

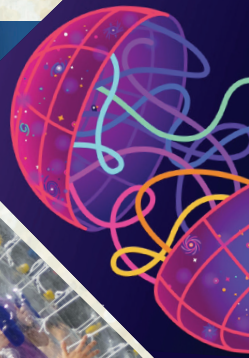

SPS & Sigma Pi Sigma



# INFORMATION HANDBOOK

2022-2023

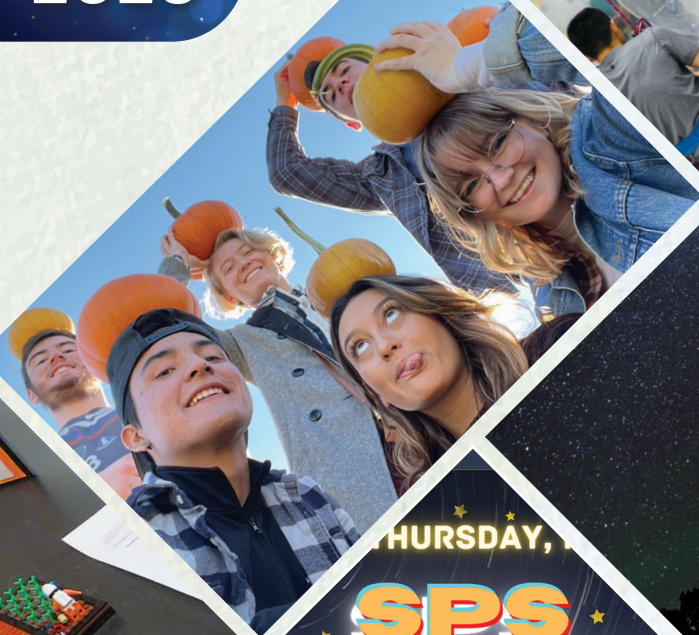

THURSDAY,  
**SPS  
DAY OF  
TALKS**

SLOANE PHYSICS LAB  
ROOM 57



PHYSICS  
YOU'RE

# OVERVIEW OF THE AMERICAN INSTITUTE OF PHYSICS

## AIP | American Institute of Physics

The American Institute of Physics is a federation of scientific societies in the physical sciences, representing scientists, engineers, educators, and students. AIP offers authoritative information, services, and expertise in physics education and student programs, science communication, government relations, career services, statistical research in physics employment and education, industrial outreach, and history of the physical sciences. AIP publishes *Physics Today*, the most closely followed magazine of the physical sciences community, and is also home to the Society of Physics Students and the Niels Bohr Library and Archives. AIP owns AIP Publishing LLC, a scholarly publisher in the physical and related sciences.

### Other AIP Member Organizations:



**Sigma Pi Sigma, the  
physics and astronomy  
honor society**  
sigmapisigma.org



**Society of  
Physics Students**  
spsnational.org

### AIP Member Societies:

American Association of Physicists in Medicine  
American Association of Physics Teachers  
American Astronomical Society  
ACA The Structural Science Society  
American Meteorological Society  
American Physical Society  
Acoustical Society of America  
AVS: Science & Technology of Materials, Interfaces,  
and Processing  
OPTICA (Formerly The Optical Society)  
The Society of Rheology

Contact  
SPS?

- General questions: 301.209.3007 or [sps@aip.org](mailto:sps@aip.org)
- Awards, Scholarships, Outreach, Internships: [sps-programs@aip.org](mailto:sps-programs@aip.org)
- Dues, Membership, and Meetings: [sps-membership@aip.org](mailto:sps-membership@aip.org)
- Sigma Pi Sigma : [sigmapisigma@aip.org](mailto:sigmapisigma@aip.org)

Our phones are staffed from 8:00 am - 4:30 pm Eastern time

**The Society of Physics Students & Sigma Pi Sigma**

1 Physics Ellipse • College Park, MD 20740 • Tel: +1 301.209.3007  
[sps@aip.org](mailto:sps@aip.org) | [spsnational.org](http://spsnational.org) | [sigmapisigma.org](http://sigmapisigma.org)



# TABLE OF CONTENTS

<b>Overview of the American Institute of Physics</b> .....	<b>2</b>
<b>Foreword: The Society of Physics Students and Sigma Pi Sigma</b> .....	<b>4</b>
Overview of the Society of Physics Students .....	4
SPS: Purpose and Mission .....	4
Overview of Sigma Pi Sigma (ΣΠΣ) .....	5
Sigma Pi Sigma: Mission .....	5
<b>Part I. Connect to SPS</b> .....	<b>6</b>
Governance of SPS & Sigma Pi Sigma .....	6
SPS Executive Committee 2022 –23 .....	6
SPS Council 2022 –23 .....	7
SPS Statements .....	9
SPS Team .....	10
Annual Calendar .....	11
SPS: Application Deadlines for Awards and Programs .....	12
SPS: Programs and Resources .....	14
Sigma Pi Sigma: Programs and Awards .....	15
Publications .....	16
SPS Membership .....	16
How to Join SPS .....	18
SPS Member Benefits .....	18
<b>Part II. Chapter Health – Development and Support</b> .....	<b>19</b>
Advisor Resources .....	20
Annual Chapter Report .....	20
Connecting with Other Chapters .....	20
Zone Meetings .....	20
Starting an SPS Chapter .....	20
Maintaining a Healthy Chapter .....	21
Other Ideas for Your Chapter .....	22
Conducting SPS Chapter Meetings and Building your Chapter .....	23
Example Chapter Activities .....	24
Sample SPS Chapter Bylaws .....	26
Seven Roles of the SPS in the Physics Community .....	27
<b>Part III. Sigma Pi Sigma (ΣΠΣ)</b> .....	<b>29</b>
Membership and Benefits .....	29
Inductions and the Ceremony .....	31
List of SPS Chapters with Installation Dates .....	32
List of Sigma Pi Sigma Chapters with Installation Dates .....	39

**Everything in this handbook is available online:**  
[spsnational.org/about/governance/sps-information-handbook](https://spsnational.org/about/governance/sps-information-handbook)

Photos are courtesy of 2019-2022 Chapter Reports.

# FOREWORD:

## THE SOCIETY OF PHYSICS STUDENTS AND SIGMA PI SIGMA



### Overview of the Society of Physics Students (SPS)

The Society of Physics Students (SPS) is a professional association explicitly designed for undergraduate students and their advisers. Membership, through collegiate chapters, is open to anyone interested in physics and astronomy. Besides physics and astronomy majors, our members include majors in chemistry, computer science, engineering, geology, mathematics, medicine, and many other fields. Everyone has a home within SPS.

At its core, SPS is a grassroots non-profit, structured as a chapter-based membership organization. With over 860 chapters located at colleges and universities across the United States and the world, SPS strives to be inclusive and supportive of the entire community.

Within SPS is housed Sigma Pi Sigma, the national physics and astronomy honor society, which elects members on the basis of outstanding academic achievement and community service. These unique, linked-but-distinct societies operate within and are underwritten by the American Institute of Physics (AIP), a federation of professional science societies.

### SPS: Purpose and Mission

SPS is a chapter-based society that exists to support departments and help students transform themselves into contributing members of the professional community. Traditional coursework develops one range of skills. Other professional skills students need include: effective communication and interpersonal networking, leadership, professional networking, effective presentation of scholarly work in professional meetings and journals, research, and science engagement with local communities through outreach. Through its members, advisers, chapters, and leadership, SPS fosters national initiatives and local impacts within the community.

Participating in SPS offers students the opportunity to enrich their college experience and advance science. An active SPS chapter serves as a vehicle for strengthening a department's sense of community, promoting cohesion, and providing professional development opportunities that courses alone cannot provide. A dynamic SPS chapter can also be an effective recruitment and retention tool for departments and programs. Involving students in an SPS chapter can be influential in transforming them from course-takers into contributing

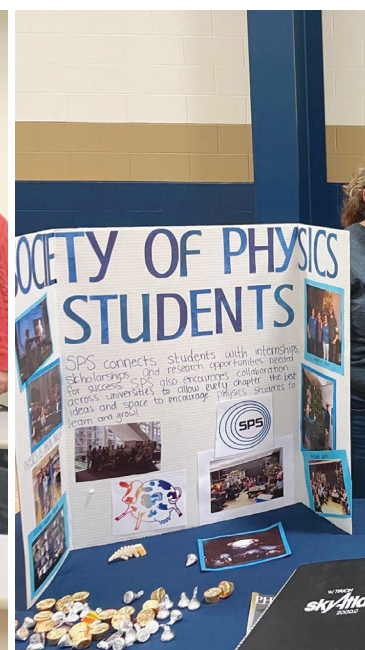

members of a professional community. SPS connects students to a global professional community of individuals interested in the physical sciences.

The Society of Physics Students was formed in 1968 with a constitution that combined its two parent organizations, the AIP Student Sections and Sigma Pi Sigma, the physics honor society. SPS now has over 860

chapters on campuses across the country. The associated honor society, Sigma Pi Sigma ( $\Sigma\Pi\Sigma$ ), has over 580 chapters of its own, with over 100,000 inductees throughout its history.

Interested in starting a new chapter? Learn more at [spsnational.org/about/governance/chapters/starting-new-chapter](https://spsnational.org/about/governance/chapters/starting-new-chapter)



# SIGMA PI SIGMA

The physics and astronomy honor society

## Overview of Sigma Pi Sigma ( $\Sigma\Pi\Sigma$ )

Founded in 1921 at Davidson College in North Carolina, Sigma Pi Sigma is the physics honor society housed within SPS. Induction into Sigma Pi Sigma is earned by outstanding academic achievement in physics and lasts for a lifetime. Sigma Pi Sigma alumni represent a wide diversity of career paths, but all members share in common a record of accomplishments in physics and astronomy. Sigma Pi Sigma has been a member of the Association of College Honor Societies since 1945.

## Sigma Pi Sigma: Mission

Sigma Pi Sigma exists to honor outstanding scholarships in physics; to encourage interest in physics among all students; to promote an attitude of service among its members toward their fellow students, colleagues, and the public; and to provide a fellowship of persons who have excelled in physics.

The Sigma Pi Sigma Mission Statement was adopted by the SPS Council on September 30, 1995 and answers the question, "Since membership in Sigma Pi Sigma is for a lifetime, what does membership in Sigma Pi Sigma mean long after the induction ceremony is over?" Sigma Pi Sigma supports departments and students alike through the ideals of service, encouragement, and fellowship.

## TO LEARN MORE

Explore the SPS website:  
[spsnational.org](https://spsnational.org)

Explore the  $\Sigma\Pi\Sigma$  website:  
[sigmapisigma.org](https://sigmapisigma.org)

Interested in starting a new chapter?  
[spsnational.org/about/governance/chapters/starting-new-chapter](https://spsnational.org/about/governance/chapters/starting-new-chapter)

General questions:  
[sps@aip.org](mailto:sps@aip.org)

Find us @SPSNational:



# PART I: CONNECT TO SPS

## 2022–23

### EXECUTIVE COMMITTEE

#### SPS President

**Kiril Streletzky**

Cleveland State University  
k.streletzky@csuohio.edu

#### Sigma Pi Sigma President

**Blane Baker**

William Jewell College  
bakerb@william.jewell.edu

#### AZC Student Representative

**Victoria "Cat" Catlett**

Green Bank Observatory  
victoria.w.catlett@gmail.com

#### AIP Representative

**Liz Dart Caron**

American Institute of Physics  
lcaron@aip.org

#### Director of SPS & ΣΠΣ

**Brad R. Conrad**

American Institute of Physics  
bconrad@aip.org

#### AIP At-Large Member

**Hannah Jang-Condell**

NASA  
hannah@alum.mit.edu

#### Historian

**Earl Blodgett**

University of Wisconsin – River Falls  
earl.d.blodgett@uwrf.edu

## Governance of SPS & Sigma Pi Sigma

SPS and Sigma Pi Sigma are chapter-based organizations, with the chapters organized into 18 geographic zones that span the globe. While chapters are chartered at the local level, each is part of SPS and Sigma Pi Sigma National and has elected officials. Leadership of these organizations is a partnership between students and faculty. SPS and Sigma Pi Sigma are governed by the SPS constitution and bylaws which can be found online at [spsnational.org/about/governance/constitution](https://spsnational.org/about/governance/constitution).

## The SPS Executive Committee 2022–23

The Executive Committee has the administrative, supervisory, and fiscal responsibility for the operations of the Society of Physics Students and approves all policies of the Society of Physics Students before they are implemented. The Executive Committee is led by the SPS President and the Sigma Pi Sigma President (both elected for two-year terms, limited to two consecutive terms), with an elected Associate Zone Councilor (AZC) representative, the AIP Chief of Staff, an at-large member appointed by the AIP CEO, the SPS & Sigma Pi Sigma Director, and the SPS & Sigma Pi Sigma Historian. This committee oversees the work of the SPS Council, provides guidance and advice to SPS staff, and acts to ensure the health and progress of the organization.

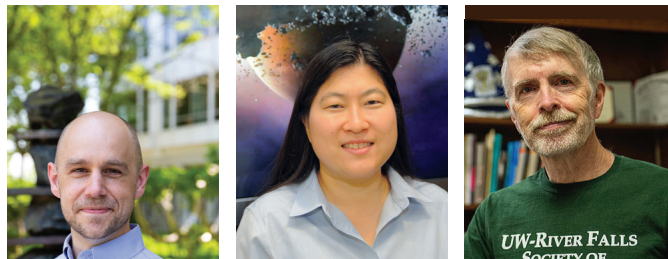

## The SPS Council 2022–23

The SPS Council is the governing body for SPS and Sigma Pi Sigma. The council is comprised of an elected faculty zone councilor (ZC) and an elected student associate zone councilor (AZC) from each of the 18 zones, an elected SPS president, and an elected Sigma Pi Sigma president. The council composition was carefully designed with students in mind, as SPS is a community of students and faculty mentors.

Elections occur during spring each year. AZCs are elected annually from each zone. ZCs are on a three-year election cycle. Elective officers may not serve more than two consecutive full terms on the Council in the same office. Each councilor speaks for all of the SPS and  $\Sigma\Pi\Sigma$  chapters and members within their zone on matters of national importance. For more information about the National Council or about the election process, visit [spsnational.org/about/governance/national-council/nominations/elections](https://spsnational.org/about/governance/national-council/nominations/elections).

Additionally, the SPS Council is charged with evaluating, planning, and driving forward the initiatives of SPS and Sigma Pi Sigma. A bulk of the work done by the National Council is accomplished through committees, which are composed of ZCs, AZCs, SPS Office staff, and invited members. The entire council meets several times each academic year to address society needs, initiatives, and endeavors.

One of the most important tasks for ZCs and AZCs is to encourage communication and facilitate collaboration among the chapters within their zone and the SPS Office. To contact your ZCs and AZCs, visit [spsnational.org/about/governance/national-council](https://spsnational.org/about/governance/national-council). They are an important resource for each chapter.



To contact your ZCs and AZCs, visit

[spsnational.org/about/governance/national-council](https://spsnational.org/about/governance/national-council)

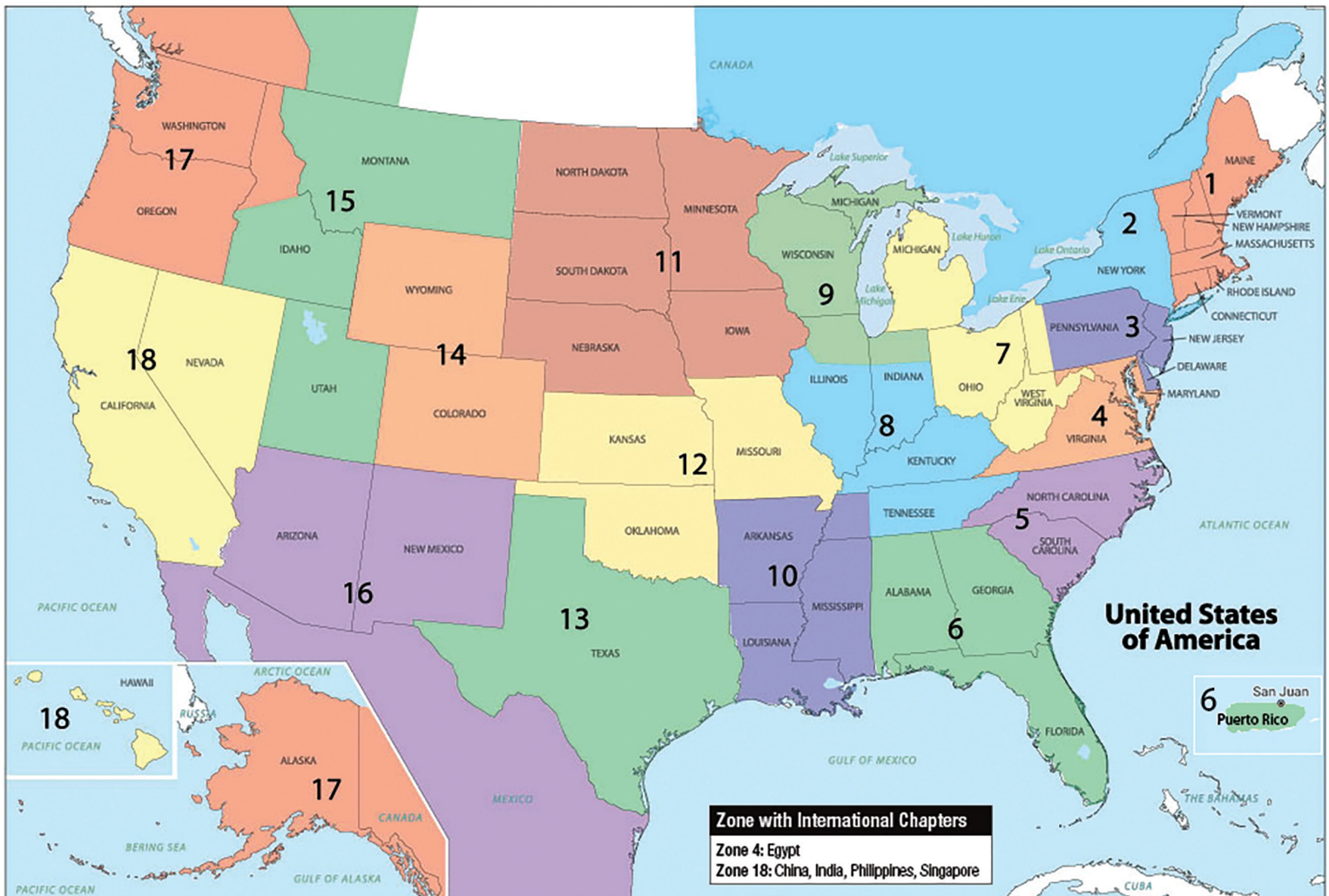

## The 2022–23 SPS and Sigma Pi Sigma National Council

1	AZC	Taylor Knapp	Brown University	taylor_knapp@brown.edu
2	AZC	Andrew McGee	Ithaca College	amcgee1@ithaca.edu
3	AZC	Sylphrena Kleinsasser	Lycoming College	ksylphrena@gmail.com
4	AZC	Shauna Shepard	Randolph College	sshepard@randolphcollege.edu
5	AZC	Aidan Keaveney	Appalachian State University	keaveneyaw@appstate.edu
6	AZC	Matt Klink	University of Alabama	mwklink@crimson.ua.edu
7	AZC	Rebecca Abbott-McCune	Kettering University A	abbo3058@kettering.edu
8	AZC	Jesse Farr	University of Tennessee at Knoxville	jfar7@vols.utk.edu
9	AZC	William Murillo	Augustana College	Williammurillo20@augustana.edu
10	AZC	Jess Hamer	Rhodes College	hamjg-23@rhodes.edu
11	AZC	Serenity Engel	South Dakota School of Mines and	serenity.engel@mines.sdsmt.edu
12	AZC	Ashley Stokes	Missouri Southern State University	stokesa004@mymail.mssu.edu
13	AZC	Zorayda Martinez	Texas A&M University - Commerce	zmartinez5@leomail.tamuc.edu
14	AZC	Alya Sharbaugh	University of Colorado Denver	alya.sharbaugh@ucdenver.edu
15	AZC	Kylie "Curly" Ellsworth	University of Utah	aquadongi02@gmail.com
16	AZC	Janessa Slone	Embry-Riddle Aeronautical University -	slonej1@my.erau.edu
17	AZC	Lauren Dressler	Lewis & Clark College	laurendressler@lclark.edu
18	AZC	Soumay Garg	Ohlone Physics	sgarg4@student.ohlone.edu
1	ZC	Nicole Gugliucci	Saint Anselm College	ngugliucci@anselm.edu
2	ZC	Matt Wright	Adelphi University	mwright@adelphi.edu
3	ZC	Roberto Ramos	Saint Joseph's University	rramos@sju.edu
4	ZC	Brendan Diamond	Howard Community College	bdiamond@howardcc.edu
5	ZC	Anthony Kuchera	Davidson College	ankuchera@davidson.edu
6	ZC	Sesha Srinivasan	Florida Polytechnic Institute	ssrinivasan@floridapoly.edu
7	ZC	Ronald Kumon	Kettering University A & B	rkumon@kettering.edu
8	ZC	Jacob Albert Hale	DePauw University	jacobhale@depauw.edu
9	ZC	Heather Whitney	University of Chicago	hwhitney@uchicago.edu
10	ZC	Shannon Clardy	Henderson State University	clardys@hsu.edu
11	ZC	Tim Kidd	University of Northern Iowa	tim.kidd@uni.edu
12	ZC	Jency Sundararajan	University of Virginia	zey9gt@virginia.edu
13	ZC	Larry Isenhower	Abilene Christian University	ldi00a@acu.edu
14	ZC	Michael "Bodhi" Rogers	University of Colorado Denver	michael.b.rogers@ucdenver.edu
15	ZC	Tamara Young	University of Utah	tamara@physics.utah.edu
16	ZC	Dwight Luhman	Sandia National Laboratory	drluhma@sandia.gov
17	ZC	Deanna Marshall	Central Washington University	deanna.marshall@cwu.edu
18	ZC	Chad Kishimoto	University of San Diego	ckishimoto@sandiego.edu



## SPS Statements

SPS Statements are public policy statements drafted and voted on by the SPS Council and voted on at its annual meeting.

The following are a few selected statements of particular importance for your chapter. The full text of all adopted statements is available at [spsnational.org/about/governance/statements](https://spsnational.org/about/governance/statements).

### ***Mental Well-being***

The Society of Physics Students (SPS) and Sigma Pi Sigma ( $\Sigma\Pi\Sigma$ ) acknowledge that the success of all students is tied to mental health. As the national organization representing those with an interest in physics, we encourage chapters and advisers to discuss issues of mental health and to identify resources for students.

### ***Diversity, Inclusion, Ethics, and Responsibility***

The Society of Physics Students (SPS) welcomes all students with a passion for physics independent of identity, regardless of but not limited to race, ethnic origin, religious beliefs, gender, gender identity, sexual orientation, disability, age, family and socio-economic status, or cultural background. Many groups are under-represented in physics and SPS and Sigma Pi Sigma have not always been welcoming to diverse groups. Today all our events are subject to our Code of Conduct, and SPS and Sigma Pi Sigma are committed to working to correct this exclusion and will continue to update our policies and best practices in pursuit of promoting diversity, inclusion, and equity.

### ***Commons Rooms, Department Health, and Identity***

The Society of Physics Students (SPS) recognizes that a physics commons room or physics lounge encourages community and provides a space for learning. Physics and Astronomy students, faculty, and guests benefit from a dedicated place for discussion and discovery. Access to a commons room empowers undergraduate students in their studies while also promoting collaboration. SPS is committed to providing resources that support and highlight student commons rooms. We encourage other groups within the physics and astronomy community to create student commons rooms with the goal of nurturing our physics communities.

### ***Climate Crisis***

The Society of Physics Students and the Sigma Pi Sigma National Council encourage chapters to sponsor, engage in, and pursue outreach events that promote awareness of the scientific basis of human-induced climate change to the general public. Furthermore, chapters are encouraged to champion initiatives that address the climate crisis and to practice environmental sustainability.

### ***Diversity***

The Society of Physics Students recognizes that there is a vast untapped intellectual resource in all groups underrepresented in physics. For this reason, the Society of Physics Students is committed to making physics more accessible to everyone. We are committed to providing programs, resources and opportunities that encourage greater participation in the community of physics from members of all groups.

### ***Inclusivity***

The Society of Physics Students (SPS) has, since its inception, been open to anyone interested in physics and recognizes that lasting engagement in the community of physics from members of all groups is vital to the sustainability of physics as a discipline. Therefore, all

SPS chapters and their members should strive to make all gatherings and events, whether formal or informal, local, regional, or national, welcoming to anyone interested in physics. The Society of Physics Students is committed to providing resources that promote and support the development of inclusive physics communities where members of all groups feel welcomed, valued, and empowered to be themselves.

### ***Outreach***

The Society of Physics Students recognizes that outreach inspires scientific literacy while promoting public understanding of the benefits of physics education and research. Community and educational partnerships also foster curiosity and passion in the next generation. These activities enrich the experience of the participating undergraduate students as ambassadors of science by promoting a deeper commitment to their discipline. We are committed to providing programs, resources and opportunities that highlight physics and encourage community outreach partnerships.

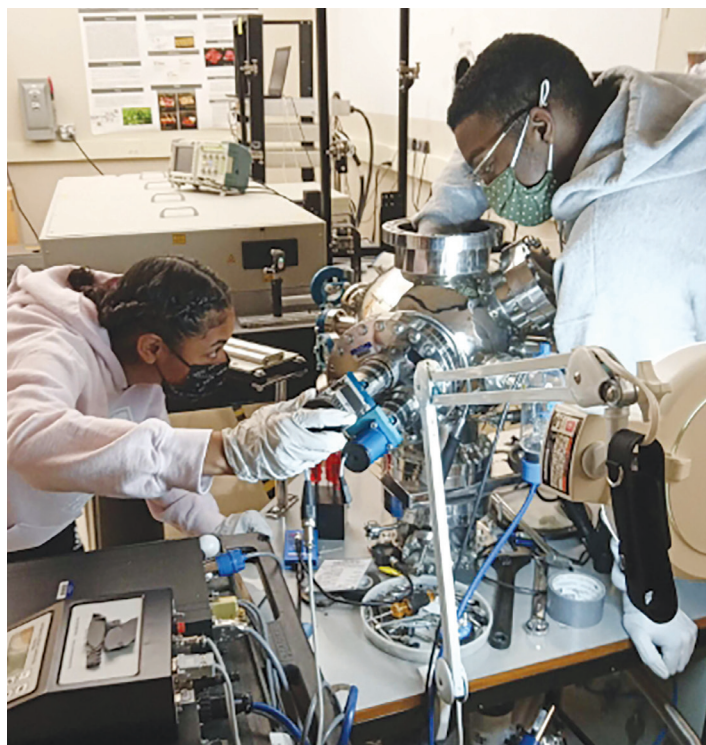

# The SPS Office

The SPS Office staff are equipped to connect our members, advisers, and chapters to the resources they need. Our phones are staffed Monday-Friday from 8:00 am - 4:30 pm Eastern time, and we can be reached anytime via email at [sps@aip.org](mailto:sps@aip.org).



**Brad Conrad**

Director, SPS and Sigma Pi Sigma  
[bconrad@aip.org](mailto:bconrad@aip.org) | (301) 209-3111



**Andrew Zeidell**

Assistant Director of Sigma Pi Sigma  
[azeidell@aip.org](mailto:azeidell@aip.org) | (301)209-3197



**Kayla Stephens**

Assistant Director of SPS  
[kstephens@aip.org](mailto:kstephens@aip.org) | (301) 209-3062



**Mikayla Cleaver**

SPS Programs Coordinator  
[mcleaver@aip.org](mailto:mcleaver@aip.org) | (301) 209-3029



**Aaron Hansen**

Creative Services Manager  
[ahansen@aip.org](mailto:ahansen@aip.org) | (301) 209-3141



**Hyun-Joo Kim**

Web and Graphic Designer  
[hjkim@aip.org](mailto:hjkim@aip.org) | (301) 209-3101



**Lydia Quijada**

SPS Membership Coordinator  
[lquijada@aip.org](mailto:lquijada@aip.org) | (301) 209-3008



**Sacha Purnell**

SPS Senior Administrator  
[spurnell@aip.org](mailto:spurnell@aip.org) | (301) 209-3011

## For questions regarding

Outreach, awards, scholarships, and internships, contact:  
[sps-programs@aip.org](mailto:sps-programs@aip.org)

SPS membership, dues, and meetings, contact:  
[sps-membership@aip.org](mailto:sps-membership@aip.org)

Sigma Pi Sigma inductions, regalia or other matters, contact:  
[sigmapisigma@aip.org](mailto:sigmapisigma@aip.org)

All other inquiries may be directed to  
[sps@aip.org](mailto:sps@aip.org)



# ANNUAL CALENDAR OF APPLICATION DEADLINES



## FALL DEADLINE

**November 15**

- Marsh W. White Award
- The Future Faces of Physics Award
- SPS Chapter Research Award
- Sigma Pi Sigma Chapter Project Award
- SPS-AAPT-ALPhA Undergraduate Award for Outstanding Laboratory Development



## WINTER DEADLINE

**January 15**

- SPS Summer Internship



## SPRING DEADLINE

**March 15**

- SPS Scholarships
- Outstanding Undergraduate Research Award
- Outstanding Chapter Advisor Nominations
- Journal of Undergraduate Reports in Physics



## SUMMER DEADLINE

**June 15**

- Chapter Reports including the Blake Lilly Prize

## ONGOING OPPORTUNITIES

- SPS Travel, Research, & Reporter Awards
- SPS Outstanding Service Awards
- SOCK Outreach Kit Requests
- Sigma Pi Sigma Service Award

For a detailed list of award and program deadlines, please visit:



[spsnational.org/awards/award-deadlines](https://spsnational.org/awards/award-deadlines)



# SPS: Application Deadlines for Awards and Programs

## Online Application System

All applications and proposals for SPS and Sigma Pi Sigma awards and programs, with the exception of the Outstanding Chapter Award, Blake Lilly Prize, and Zone Meeting Grants, are handled via a single online system. Details on how to apply and a link to the online application system are available on the award webpages, [spsnational.org/awards](https://spsnational.org/awards), or through your SPS membership profile [membership.spsnational.org](https://membership.spsnational.org) (click on “SPS Awards Application” in the upper right hand area).

Award and Program Deadlines are broken into four application periods. For a detailed list of award and program deadlines please visit [spsnational.org/awards/award-deadlines](https://spsnational.org/awards/award-deadlines)

## Fall Deadline: Applications due November 15

### Future Faces of Physics Award

[spsnational.org/awards/future-faces](https://spsnational.org/awards/future-faces)

- Several awards of up to \$500 may be made each year
- Awarded to chapters for activities that promote physics or astronomy related across cultures

### Marsh W. White Award

[spsnational.org/awards/marsh-white](https://spsnational.org/awards/marsh-white)

- Several awards of up to \$500 may be made each year
- Awarded to chapters for physics and astronomy outreach activities to grades K-12 and the general public

### SPS Chapter Research Award

[spsnational.org/awards/chapter-research](https://spsnational.org/awards/chapter-research)

- Several awards of up to \$2,500 may be made each year
- Awarded to chapters for physics and astronomy research projects

### Sigma Pi Sigma Chapter Project Award

[sigmapisigma.org/sigmapisigma/awards/chapter-project](https://sigmapisigma.org/sigmapisigma/awards/chapter-project)

- For details, see the “ΣΠΣ Awards” section

### AAPT-ALPhA Undergraduate Award for Outstanding Laboratory Development

[spsnational.org/awards/outstanding](https://spsnational.org/awards/outstanding)

- Awarded to (an) undergraduate(s) on the basis of their exceptional contributions to advanced laboratory development and letters of recommendation.
- Winners will present their work at the summer national AAPT meeting, supported by a \$1,000 student travel award, a \$500 faculty travel award, a \$500 student honorarium, and a \$500 award to the department to advance the department’s advanced laboratory.

## Winter Deadline: Applications due January 15

### SPS Internship Program

[spsnational.org/programs/internships](https://spsnational.org/programs/internships)

- For details, see the “SPS Programs & Resources” section

### SPS Congressional Visits Day

[spsnational.org/programs/sps-cvd](https://spsnational.org/programs/sps-cvd)

- For details, see the “SPS Programs & Resources” section

## Spring Deadline: Applications due March 15

### SPS Scholarships

[spsnational.org/awards/scholarships](https://spsnational.org/awards/scholarships)

Scholarships are applied for via one application through the online awards system. Applicants are encouraged to apply for all scholarships that they qualify for. SPS Scholarship amounts and eligibility are listed below:

#### SPS Leadership Scholarship

- Several \$2,500-\$6,000 awards may be made each year
- Applicants must have junior level standing
- Awarded on the basis of academic performance and leadership in SPS

#### Herbert Levy Scholarship

- One \$2,500 award may be made each year
- Awarded to undergraduate students on the basis of scholarship, SPS participation, and financial need
- Established in the memory of the late Dr. Herbert Levy, by Margaret Sussman Levy

#### Future Teacher Scholarship

- One \$2,500 award may be made each year
- Awarded to undergraduate students on the basis of scholarship, SPS participation, and a stated teaching career objective(s)

#### Peggy Dixon Two-Year Scholarship

- One \$2,500 award may be made each year
- Awarded to undergraduate students on the basis of scholarship, SPS participation, and attendance at a two-year college
- Established in the memory of the late Dr. Peggy Dixon

#### Kirsten R. Lorentzen Award

- One \$2,000 award is made each year
- Awarded to a female student in her sophomore or junior year of study
- Awarded to an exceptionally well-rounded student who excels in her studies as well as outdoor activities, service, sports, music, or other non-academic pursuits or who has overcome significant obstacles
- The Lorentzen Award is an Association for Women in Science (AWIS) Educational Foundation program administered by SPS

#### Science Systems and Applications, Inc. (SSAI) Academic Scholarship

- One \$2,000 award may be made each year
- Awarded to undergraduate students on the basis of scholarship and SPS participation

### Science Systems and Applications, Inc. (SSAI) Underrepresented Student Scholarship

- One \$2,000 award may be made each year
- Awarded to undergraduate students who are from a group that is underrepresented in science and engineering, on the basis of scholarship and SPS participation

### LLNL-AIP Leadership Scholarship

- Up to three \$2,000 may be awarded and funded in conjunction with the SPS Leadership Scholarships
- Awarded on the basis of academic performance and SPS/department participation

### SPS and AAPT Mary Beth Monroe Memorial Scholarship

- One \$2,500 award may be made each year
- Awarded to undergraduate students majoring in physics or physics education on the basis of scholarship, SPS participation, attendance at a community college, and intent to pursue a career in education

### Outstanding SPS Chapter Advisor Award

[spsnational.org/awards/outstanding-chapter-advisor](https://spsnational.org/awards/outstanding-chapter-advisor)

- One award is made each year to a chapter advisor, nominated by their students
- Winners receive \$6,000: 60% to the chapter advisor, 20% to the chapter, 20% to the department
- Awarded to a chapter advisor whose chapter has received an Outstanding Chapter Award within the preceding two years during their tenure as SPS chapter advisor
- Awarded on the basis of leadership, student leadership development, chapter support, and encouragement the advisor has provided to the chapter

### SPS Award for Outstanding Undergraduate Research

[spsnational.org/awards/outstanding-undergraduate-research](https://spsnational.org/awards/outstanding-undergraduate-research)

- Two or more awards may be made each year
- Awarded to SPS members on the basis of their research, letters of recommendation, and SPS participation
- Winners are able to attend and present their research at a AIP member society meeting of their choice (registration and travel costs up to \$1,800 are eligible for reimbursement)
- Receive a \$500 honorarium for themselves and a \$500 honorarium for their SPS chapter

## Summer Deadline: Applications due June 15

### SPS Annual Chapter Reports

[spsnational.org/resources/chapters/annual-chapter-reports](https://spsnational.org/resources/chapters/annual-chapter-reports)

Submission of an SPS Annual Chapter Report qualifies your chapter for the Outstanding SPS Chapter Award and other chapter designations. Within the Chapter Report, you can apply for the Blake Lilly Prize.

For details about Chapter Reports, please see the “SPS Chapter Health” section.

### SPS Outstanding Chapter Award

[spsnational.org/awards/outstanding-chapter](https://spsnational.org/awards/outstanding-chapter)

- Several awards may be made in each zone every year
- Winners receive a certificate and national recognition
- Awarded to chapters that demonstrate active involvement on the local, zone, and national levels in keeping with the mission of SPS

### Blake Lilly Prize

[spsnational.org/awards/blake-lilly](https://spsnational.org/awards/blake-lilly)

- One award per zone may be made each year
- Winners receive a physics or astronomy related publication and a certificate
- Awarded to chapters or individuals that engage in physics outreach activities
- Established in the memory of the late Blake Lilly by his parents

## Ongoing Application Opportunities

### SPS Travel Award

[spsnational.org/awards/travel](https://spsnational.org/awards/travel)

Applications are accepted on a rolling basis up to 10 business days before the conference

- Multiple \$300 awards may be made each year for meetings
- Awarded to SPS members presenting their research at AIP Member Society national meetings
- Awarded to undergraduates on a first-come first-served basis
- Limited to one award, per person, per academic year

### SPS Reporter Award

[spsnational.org/awards/reporter](https://spsnational.org/awards/reporter)

Applications are accepted on a rolling basis up to 10 business days before the conference

- Multiple \$300 awards may be made each year for meetings
- Awarded to SPS members reporting on national professional meetings for SPS publications
- Awarded to undergraduates, on a first-come first-served basis
- Limited to one award, per person, per academic year

### SPS Research Travel Award

[spsnational.org/awards/research](https://spsnational.org/awards/research)

Applications are accepted on a rolling basis up to 10 business days before the event

- Multiple \$300 awards may be made each year for meetings
- Awarded to SPS members conducting research at national labs, observatories, or similar institutions.
- Awarded to undergraduates, on a first-come first-served basis
- Limited to one award, per person, per academic year

### SPS SOCKs (Science Outreach Catalyst Kits)

[spsnational.org/programs/outreach/science-outreach-catalyst-kits](https://spsnational.org/programs/outreach/science-outreach-catalyst-kits)

Applications are accepted on a rolling basis throughout the academic year

- For details, see the “SPS Programs & Resources” section

### SPS Zone Meeting Kits and Grants

[spsnational.org/meetings/zone-meetings/funding](https://spsnational.org/meetings/zone-meetings/funding)

Applications are accepted on a rolling basis up to 10 business days before the zone meeting

- Up to \$900 per zone per year may be allotted to the chapter hosting the zone meeting
- You can also request SPS brochures and posters with your meeting kit
- A final report is required to receive all funds
- This is NOT accessible via the online awards system, please email [lquijada@aip.org](mailto:lquijada@aip.org) for details

## The SPS Outstanding Service Award

[spsnational.org/awards/service](https://spsnational.org/awards/service)

Applications are accepted on a rolling basis

- Awarded to faculty and students who exemplify an attitude of service to the discipline of physics and astronomy through actions at the local, national, or international level
- Nominees should have had a positive impact on an SPS chapter, a department, or the broader community
- Recipients receive plaque purchased from the National office by the awarding chapter
- Nomination packets are reviewed by the Director of SPS and Sigma Pi Sigma and the SPS President, in consultation with the SPS Executive Committee

## SPS: Programs & Resources

### SPS Internship Program

[spsnational.org/programs/internships](https://spsnational.org/programs/internships)

The SPS summer internship program offers 10-week positions for undergraduate physics and astronomy students in science research, education and policy with various organizations in the Washington, DC area. Eligible applicants must be undergraduates, members of the SPS organization, and have at least two years of college physics (or equivalent). SPS summer interns receive a stipend of \$6,500, local housing, travel costs, and have the opportunity to participate in a number of engaging supplemental activities that explore the full range of career options available to physics majors.

### SPS SOCK (Science Outreach Catalyst Kits)

[spsnational.org/programs/outreach/science-outreach-catalyst-kits](https://spsnational.org/programs/outreach/science-outreach-catalyst-kits)

Science Outreach Catalyst Kits, or SOCKs, contain an exploratory physics and science activity that is specifically designed for SPS chapters to use in outreach presentations to elementary, middle and high school students. Each SOCK comes with the basic materials to conduct a set of demonstrations, a comprehensive manual, and instructions on how to expand the demonstration to become a tried-and-true outreach activity. SOCKs are designed and implemented annually by the SPS SOCK Intern and National Office staff.

### SPS Outreach Demonstrations

[spsnational.org/programs/outreach/demonstrations](https://spsnational.org/programs/outreach/demonstrations)

Looking for a new demonstration for an outreach event? Want to jump start your chapter on outreach? SPS staff and interns have designed easily-accessible online demonstrations to help you make a difference in your local communities. Each demonstration includes a parts lists, instructions, key physical concepts to explain, and demonstration videos (where appropriate).

### SPS Alumni Engagement Program

[spsnational.org/programs/alumni-engagement](https://spsnational.org/programs/alumni-engagement)

The Alumni Engagement program provides SPS alumni and  $\Sigma\Pi\Sigma$  members the opportunity to stay connected with the undergraduate physics and astronomy community. Through the Alumni Engagement Program, alumni can sign-up to be a part of the SPS Speakers Bureau, volunteer for the Adopt-a-Physicist program, conduct informational interviews, and even mentor current SPS students. Chapters and SPS Members can search for alumni based on location and type of requested interaction, SPS will assist in matching the requests to volunteers.



## Careers Toolbox for Undergraduate Students and their Mentors

[spsnational.org/careerstoobox](https://spsnational.org/careerstoobox)

The Careers Toolbox for Undergraduate Physics Students and their Mentors, a product of the Careers Pathways Project, is a set of professional development tools that guide students through their career options and prepare them for success in the job search. Careers Toolbox workshops materials are available online and the print version is available for purchase in the online SPS store.

## Graduate School Resources

[GradSchoolShopper.com](https://gradschoolshopper.com)

GradSchoolShopper.Com is the most comprehensive resource for undergraduates looking for graduate programs in the physics, astronomy, and related fields. Students can search for their graduate schools by research specialty, acceptance rate, due dates, campus setting, and location! The GradSchoolShopper directory lists a programs in related-fields, including materials science, engineering, chemical physics, optics, and many more.

## Additional Grad School Resources

Looking for advice for navigating the graduate school admission process or information on the Physics GRE? SPS provides resources and articles to help you find the best graduate school and program for you. Visit [spsnational.org/career-resources](https://spsnational.org/career-resources) for access to all SPS Graduate School resources.

## Physicist Profiles

[spsnational.org/career-resources/physicist-profiles](https://spsnational.org/career-resources/physicist-profiles)

SPS compiles physicist profiles to help students, parents, and the public learn about the diverse career paths available to those who study physics, and typical factors associated with various jobs. Read about career options or submit a profile yourself!

## Psi\* and Physics for Humans

[www.spsnational.org/programs/outreach/psistar](https://www.spsnational.org/programs/outreach/psistar)

The purpose of Psi\* is to bring physics students' inventiveness to fruition through material and creative support; to foster employer, investor, and community awareness of the potential for innovation by physics students in the service of human needs; and to engage physics alumni to use their experience to aid student innovators.

## Sigma Pi Sigma (ΣΠΣ): Programs and Awards

Sigma Pi Sigma programs are grounded in its mission to honor outstanding scholarship in physics; to encourage interest in physics among students at all levels; to promote an attitude of service of its members toward their fellow students, colleagues, and the public; and to provide a fellowship of persons who have excelled in

physics. Programs are funded by generous donations of alumni and underwritten by the American Institute of Physics. To learn how you can contribute, see [donate.aip.org](https://donate.aip.org).

## ΣΠΣ Service to High School Physics Classes: Adopt-a-Physicist

[adoptaphysicist.org](https://adoptaphysicist.org)

Adopt-a-Physicist connects high school students to physics degree recipients, recruited primarily from among the Sigma Pi Sigma membership. These adoptees are eager to share their stories as a means of helping students understand the benefits of studying physics and the career opportunities it provides. Working in areas ranging from particle physics research to freelance writing, the participating physicists embody a huge range of careers, backgrounds, interests, and educational levels. Adopt-a-Physicist connects classes with the physicists of their choice through online discussion forums that are active for a specific three-week session.

## ΣΠΣ Awards

Awards issued by Sigma Pi Sigma, the physics honors society

[sigmapisigma.org/sigmapisigma/awards](https://sigmapisigma.org/sigmapisigma/awards)

### Worth Seagondollar Award

The most prestigious award offered by Sigma Pi Sigma

#### Applications accepted on a rolling basis

- Recipients receive a medal and certificate
- Awarded to individuals who have served on the SPS Council or Executive Committee and demonstrated extraordinary levels of service and commitment to Sigma Pi Sigma and the Society of Physics Students
- Nominations may be submitted by members of Sigma Pi Sigma or the SPS Council, and selection requires a unanimous vote of the SPS Executive Committee

### Sigma Pi Sigma Outstanding Service Award

#### Applications accepted on a rolling basis

- Awarded to individuals who have performed meritorious service to the field of physics, to Sigma Pi Sigma, or to a local Sigma Pi Sigma chapter
- Awards can be bestowed by individual chapters and do not need approval from SPS
- Recipients receive recognition and certificate

### Sigma Pi Sigma Chapter Project Awards

#### Applications due November 15

- Several awards of up to \$500 may be made each year
- Awarded to Sigma Pi Sigma chapters for funding of chapter inductions and events that aim to engage alumni or expand the recognition of Sigma Pi Sigma within the campus and surrounding community

## Publications

[spsnational.org/resources/publications](https://spsnational.org/resources/publications)

### ***The SPS Observer***

Each issue of *The SPS Observer* contains interesting topic-specific feature articles, advice from experienced voices, chapter and zone activities, physics problems, alumni connections, society news, announcements, and meeting notes from SPS reporters. It is published in print and online formats in the Fall, Winter, and Spring. Print subscriptions are mailed to the SPS Advisor at each chapter and all individual members.

### ***Journal of Undergraduate Reports in Physics***

The *Journal of Undergraduate Reports in Physics* (JURP) is a focal point for professional communication within the physics and astronomy undergraduate community. Printed annually, articles published in JURP are hosted by AIP Publishing and include, but are not limited to physics, astronomy, and related fields. JURP is free for undergraduate SPS members. JURP is available in print and online formats.

### **SPS News**

*SPS News* is the e-newsletter from the Society of Physics Students. SPS News is delivered to current SPS members' email inboxes during the academic year and monthly during the summer. Issues cover chapter- and program-related deadlines and announcements, upcoming scientific and member society meetings, zone meetings, REU and internship opportunities, SPS featured jobs, and more.

### ***Radiations***

*Radiations* is the official publication of Sigma Pi Sigma. Published biannually, each issue contains interesting feature articles, connections to the broader world around us, community and member activities, physics news, society updates, member spotlights, and thought provoking pieces written by members. It is published in hard copy format and online. Subscriptions are included with your lifetime Sigma Pi Sigma membership dues.

## SPS Membership

### **Local connection to a global community**

SPS represents all students interested in physics and astronomy. SPS helps to build a community and voice for undergraduate students. Membership in the national organization of the Society of Physics Students is an important first-step in professional affiliation for students. Connection to SPS helps students and mentors transform themselves into members of the professional community. As SPS is a partnership between students and faculty, advisors are encouraged to join to take advantage of the resources SPS provides to support department health and promote a sense of community.

### **A professional organization for students and their mentors**

While coursework provides the necessary foundation in physics and astronomy, success in classes develops only one range of essential skills. SPS enables students to transform from "course-takers" into contributing members of the professional science community.

### **Connecting students and their mentors with opportunities**

SPS provides students with opportunities to develop effective professional communication skills, gain leadership experience, and be part of an international professional network. A lifetime of interactions begins with SPS. Active involvement as an SPS member provides opportunities to present research at professional meetings, professional development tools and advice, access to a robust online job portal and career building resources, science outreach tools, connections to in the local community and beyond, and eligibility for competitive SPS scholarships, grants, and awards.

### **Discover a wide range of career options**

SPS supports the Careers Toolbox and GradSchoolShopper. These tools are designed to equip physics and astronomy departments and their students with resources for effective career preparation - whether or not that includes graduate school.

The Careers Toolbox was designed to identify common features among physics departments with a strong record of preparing physics bachelor's for the science, technology, engineering, and mathematics (STEM) workforce and to disseminate that information to the physics community. Available as both workshop materials and a standalone student guide, the Careers Toolbox is designed to help undergraduate physics and astronomy students prepare to enter the science, technology, engineering, and mathematics workforce. The Careers Toolbox is a free-downloadable resource and can be found here - [spsnational.org/sites/all/careerstoolbox/](https://spsnational.org/sites/all/careerstoolbox/).

GradSchoolShopper.com a comprehensive directory of graduate programs in physics, astronomy, and related fields. Participating departments update their highly searchable program profiles annually, allowing students to find programs based on specialty, location or other key search terms. Additional data is also made downloadable so that students can compare programs by acceptance rate, deadlines, enrollment data and more. Each September GSS issues a magazine of advice and guidance specific to finding a grad program in physics, astronomy or a related field. The content is available alongside the searchable programs on the GSS website as well as in print.

### **SPS: working to improve the undergraduate experience**

SPS is open to anyone interested in physics and astronomy, welcoming students from all majors and diverse backgrounds to participate in the great science of physics. Locally, regionally, nationally, and internationally, SPS provides important enrichments to the students' experience. Faculty mentors and other members of the physics community are also encouraged to be part of SPS.

## How to Join SPS

Membership in SPS provides many benefits and access to local, regional, and international programs and awards. There are three ways to join as an SPS member.

### **Individual Membership - Best for immediate membership**

You can join SPS immediately to access awards and scholarships for \$24 per year (\$30 for international addresses). With this membership type, you receive a printed version of *The SPS Observer*. Log-in to [membership.spsnational.org](https://membership.spsnational.org) 24/7 to join or renew.

### **Group Membership**



If your chapter has at least 5 members, we offer a group discount in which you save by submitting multiple registrations at a time. The more people who join, the larger your discount. This discount is available to undergraduates, graduate students, faculty, and staff and these members receive the same benefits as individual members. Visit [spsnational.org/about/membership](https://spsnational.org/about/membership) for details.

## Chapter Membership

For a flat rate of \$350, your entire chapter becomes SPS members, including students and faculty. Through the chapter membership program, your chapter receives benefits such as copies of the Careers Toolbox, officer lapel pins, and an SPS wall decal for your lounge/department. Individuals participating in the Chapter Membership program will receive an electronic subscription to The SPS Observer. Visit [spsnational.org/about/membership](https://spsnational.org/about/membership) for details.

## SPS Member Benefits

SPS paid members receive:

- *Physics Today* (monthly): A monthly award-winning publication
- *The SPS Observer*: magazine for undergrad physics and astronomy majors
- *Journal of Undergraduate Reports in Physics (JURP)*: An annual publication of scholarly reports by SPS undergraduate members
- Free membership in two AIP Member Societies for up to three years (undergraduates only)
- Free membership in the National Society of Black Physicists (NSBP) and/or the National Society of Hispanic Physicists
- Eligibility to apply for grants, scholarships, internships, and other awards/programs
- Eligibility for outreach and chapter research monetary awards
- Physics demonstrations and free outreach kits (SOCKs)
- Research and travel grants to attend regional and national meetings
- PhysCon – the largest national undergraduate conference for physics and astronomy majors
- SPS News (bi-weekly): electronic newsletter highlighting SPS meetings, upcoming awards and programs, physics news, and other items of interest to the undergraduate physics community
- Careers Toolbox for Undergraduate Physics Students and their Mentors
- GradSchoolShopper.com
- Professional development opportunities
- Connection to undergraduate-specific regional conferences and meetings
- Opportunity to run for the SPS council and serve on SPS committees
- Access to policy alerts and government advocacy events
- Community service events and outreach
- Diversity and inclusion resources & best practices for your chapter



## What is JURP?

The Journal of Undergraduate Reports in Physics (JURP) is a peer-reviewed publication of the society of Physics Students comprised of research, outreach, and scholarly reporting.

JURP provides exposure for SPS members conducting physics and astronomy research while also supporting faculty who conduct undergraduate research and scholarship through peer-reviewed publication.

### Scholarship

Independent research across all of physical sciences: physics, quantum, astronomy, engineering physics, astrophysics, optics, mathematical physics, nano-science, acoustics, meteorology, physics education, particle physics, electronics, medical physics, and more

### Research

Peer-reviewed papers within any area of physics and astronomy research. Accepted research submissions will be indexed and searchable.

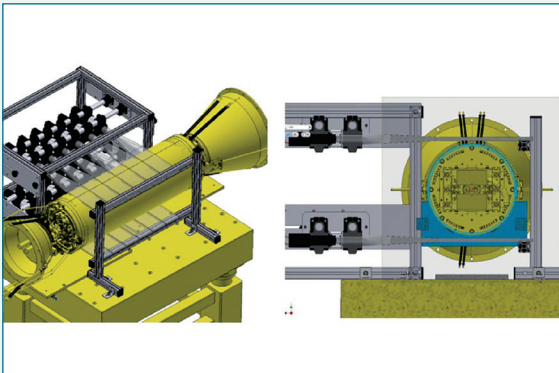

## Submit Your Report!

All current SPS members are eligible to submit to JURP. The author(s) must have performed all the work reported in the paper as an undergraduate student.

SPS will accept the submissions to JURP on a rolling basis, but final deadline for the print edition is **March 15**. JURP is FREE for undergraduate SPS members students.

# PART II:

## SPS CHAPTER HEALTH – DEVELOPMENT AND SUPPORT

### SPS Community – It starts with your chapter!

While SPS and Sigma Pi Sigma are nationally driven, the success of the organization depends on the activities carried out by the over 850 chapters at colleges and universities across the globe. Each chapter is unique. The initiatives, programs, and opportunities conceived and planned by the SPS Council are personalized by each chapter to best serve the interest of the local chapter's members, department, campus, and geographical setting.

It is through local chapter activities that students become involved with SPS outreach, awards, scholarship opportunities, research, professional development opportunities, networking, and so much more. Each individual chapter has a constitution and set of bylaws modeled after the SPS constitution that detail how the organization functions at the chapter level.



## Advisor Resources

A supportive SPS Advisor is key to the success of an SPS chapter. Among their many roles, the SPS Advisor supports chapter growth and development. They guide student leaders in identifying chapter goals and objectives, encourage officer development, and serve as a liaison between the chapter, faculty, and SPS. SPS Advisors promote an active and healthy community that represents the students' interests, year after year through leadership transitions. To better help advisors in their important role, SPS has developed a suite of resources available at: [spsnational.org/resources/advisors](https://spsnational.org/resources/advisors).

## Annual Chapter Report

To be eligible for the SPS Outstanding Chapter Awards and the SPS Outstanding Chapter Advisor award, each SPS chapter must submit an annual chapter report ([spsnational.org/resources/chapters/annual-chapter-reports](https://spsnational.org/resources/chapters/annual-chapter-reports)). These reports convey the many and varied activities of local chapters and provide important data used by the SPS Council and National Office to advocate for programs, funding, and other support for local chapters. Those chapters that clearly exhibit and carry out SPS initiatives for their campus, community, and zone can be named as SPS Outstanding Chapters (learn more about Outstanding Chapters at [spsnational.org/awards/outstanding-chapter](https://spsnational.org/awards/outstanding-chapter)). Outstanding Chapters are selected by the ZCs and AZCs on the SPS Council.

The SPS Council reviews all Chapter Reports to share the best practices.

**If you are seeking ideas, don't hesitate to reach out to your AZC and ZC to learn about programs and initiatives that have worked for other chapters.**

## Connecting with other Chapters

[spsnational.org/about/governance/zones/zone-directories](https://spsnational.org/about/governance/zones/zone-directories)

Chapters are also encouraged to plan joint activities with other chapters. You can find contact information for other chapters in your zone by contacting your zone leadership or through searching the SPS online zone directory. Your AZC and ZC may also set up other ways for chapters to communicate including Facebook groups, listservs, or Googlegroups. Be sure to watch out for these channels and contribute announcements and news from your chapter.

Possible opportunities to collaborate include physics and astronomy outreach days at local amusement parks, co-hosting a speaker, taking a tour of a nearby research facility, or even just a social event like a picnic or trivia night.

## Zone Meetings

Each zone is encouraged to host at least one zone meeting each year. These are typically coordinated by the AZC and ZC of the zone, but any institution within a zone may work with their zone leadership to serve as a host or co-sponsor. Synopses of past meetings, a list of upcoming zone meetings and information on how to host a zone meeting can be found online at [spsnational.org/meetings/zone-meetings](https://spsnational.org/meetings/zone-meetings). The National Office has toolkits available to assist zones with planning, publicizing and executing these meetings.

Zone meetings are important networking opportunities between SPS members, chapters, and the professional physics and astronomy community. A typical zone meeting includes both scientific and social components. The scientific program may feature speakers, poster presentations by students, tours of campus, or industrial site visits. Social events may include icebreakers, team building activities like a ropes course, physics and astronomy trivia, meals, design competitions, service projects, or joint outreach events. When planning your zone meeting be sure to include lots of time for your attendees to meet one another. It's through these connections that our community grows stronger!

## Starting an SPS Chapter

All institutions of higher education which regularly offer at least a two-year curriculum that includes physics and astronomy and are accredited by the appropriate national or regional accrediting agency are eligible to have a Society of Physics Students chapter.

Chapters are chartered via petition to the SPS Executive Committee. Instructions and a template of the petition are available at: [spsnational.org/about/governance/chapters/starting-new-chapter](https://spsnational.org/about/governance/chapters/starting-new-chapter).

All chapters should have a slate of student officers and official faculty or staff advisor. Once the SPS Executive Committee has approved the petition, SPS will be in touch regarding specific procedures for installing your chapter.

## Maintaining a Healthy Chapter

The following list of principles, tips, and suggestions, can help your chapter remain active, healthy, and an integral component of your physics and astronomy department:

**1) Decide that your SPS chapter is going to make a meaningful contribution to the students and department.**



Decided that your chapter is going to make meaningful contributions to the professional development of the students, and to the culture of your department and that YOU are going to be the person who makes it happen.

## 2) Decide from the beginning that your chapter will participate in SPS Zone meetings.

Such involvement will pump everything else your chapter hopes to accomplish. Contact your Zone Councilor and Associate Councilor for information about the next meeting on your Zone or nearby Zones, or check listings at [spsnational.org/meetings/zone-meetings](https://spsnational.org/meetings/zone-meetings). Make necessary plans (e.g., fund raising) well in advance. Be innovative in ways to cut expenses (e.g., some host chapters will invite visitors with space to roll out sleeping bags in the homes and dorm rooms of their members).

## 3) Plan local meetings, tours, and social events; about one event per month.

Your chapter will benefit from SPS-sponsored chapter colloquiums with local speakers (these can be part of the department's regular colloquium schedule, or a separate schedule run by SPS), and tours of nearby academic or industrial laboratories. Showing a physics or astronomy-related video or science-fiction film is enjoyable. Include several social events on your calendar (e.g., parties and picnics). Fellowship is very important.

For speakers, ask physicists and other scientists from your campus or nearby schools, and local engineers and other technical people who use the sciences and mathematics in industry and business. Local speakers will usually speak to student groups at no charge to you, but do not forget to practice hospitality (e.g., have cookie time before the talk, and, if possible, take the speaker to dinner afterwards).

## 4) Look to the future.

This begins with Zone participation, and continues by "taking physics and astronomy on the road," with programs such as "Physics Circuses" to local grades K-12. Until every physicist (including the undergraduate physicist) is at least taking lenses and magnets into a local elementary school classroom, and working cooperatively with the teacher there to encourage the pupil's interest in science, we as a professional community are not doing all we know to do for science literacy and appreciation. When it comes to science outreach to grades K-12 and the general public, the SPS can show the rest of the professional community the way.

Set up a math-physics tutoring service for your campus or a nearby elementary or secondary school. Help a local school organize and judge its science fair. Collaborate with other campus student organizations in projects of mutual interest. Present papers on your outreach programs at Zone meetings.

To assist your outreach activities, the SPS publishes The Physics Outreach Notebook. When your chapter has an established outreach program, you may wish to submit an article about it for publication in the Notebook. Other chapters may be able to adapt your ideas.

## 5) Involve students in undergraduate research experience.

The research experience does not have to be publishable—the publishable stuff can come later, and the objectives of undergraduate research are too important to leave only to publishable projects. These objectives include the following:

1. developing the skills and habits of mind that cannot be taught in courses,
2. acquiring communication skills in presenting results at Zone meetings, and
3. becoming a participant in the life of the professional community through involvement in meetings.

As a possible aid to starting and maintaining an undergraduate research program, even with zero funding, the SPS Office has published the booklet *How to Involve Undergraduates in Research* available at [spsnational.org](https://spsnational.org).

## 6) Make SPS visible.

Send your campus and other local newspapers descriptions of your members' outreach efforts to the local community, your participation in professional meetings, and other activities. Send the SPS Office newsworthy items that we can pass on to other chapters. Place an SPS mailbox in the department mailroom, obtain an electronic mail address for SPS use, and arrange for an SPS student office/lounge. Point out to the department chair that these amenities are an investment in the esprit de corps of the physics and astronomy majors. When the majors "own" a piece of the department, they have a sense of identity with it that course work alone cannot provide. Participate with other campus organizations in projects of campus-wide interest. Have an exhibit on new-student welcome week. If your school has a homecoming parade, have an SPS entry in it!

SPS chapters are encouraged to make their own logo, based off the SPS logo. Logos are available here: [www.spsnational.org/about/society-media/logos-branding](https://www.spsnational.org/about/society-media/logos-branding)



## 7) Make your chapter a valuable asset to the physics and/or astronomy department.

The *esprit de corps* of your chapter can set the tone for the departmental culture. The accomplishments of your chapter can serve as an important and documentable asset in the recruitment of prospective students. Your chapter meetings can serve as colloquiums for the department.

## 8) Involve freshmen, sophomore, and transfer students.

Too often an active chapter becomes inactive when one or two student leaders graduate. To make meaningful activity in your chapter a tradition, invite students to join SPS as soon as possible, and get them involved in all your activities and events without delay. Posters on campus and scheduled five-minute presentations in introductory university physics and astronomy courses are helpful, and personal contacts are especially effective. Make sure some newer students attend Zone meetings, even if they go as spectators. While their colleagues present papers they begin visualizing themselves presenting papers too. If you have more volunteers than jobs, create more jobs (e.g., “chapter publicist,” “chapter historian,” etc., are all useful titles).

## 9) If your chapter does not already have a Sigma Pi Sigma chapter, take steps towards chartering one.

See the Sigma Pi Sigma Mission Statement, and information about chartering a chapter of Sigma Pi Sigma: [sigmapisigma.org/sigmapisigma/about/chapter-resources](http://sigmapisigma.org/sigmapisigma/about/chapter-resources).

## 10) Look over the Chapter Annual Report Form and SPS Calendar now.

These will help you get started by providing objectives at which to aim. In May, be sure to send the completed report to the SPS Office by the deadline date. That way, your chapter will be eligible for an “Outstanding Chapter Award.”

## Other Ideas for Your Chapter

### For SPS Meetings and Colloquia:

- SPS colloquiums can include student speakers, such as those practicing their talks before going to Zone meetings, or those who recently completed a summer research project.
- Informal lunch “brown bag” meetings, with a speaker describing some project or recent trip to a conference are enjoyable.
- Discuss resume writing, job interviews, and the job market.
- Discuss recent articles in physics and astronomy magazines or journals.
- Invite the department chairperson to an informal rap session on what the department is doing, what its goals and problems are.
- Invite recent alumni to talk about their graduate school and/or employment experiences.

### Physics and astronomy Outreach to Grades K-12 and the Public:

- Develop a “Physics Circus” or other program to take into local schools (or that they can attend on your campus).
- Invite local high school physics students to join SPS as members of your chapter and participate in your programs (there are no high school SPS chapters). This is also a splendid student recruitment tool for your department.
- Arrange for public viewing of astronomical objects through the department’s telescopes.

- Working with the chemistry and biology departments, arrange for tours of your campus laboratories by school children.
- Help coach pre-college students for the exams that seek the United States Physics Team for the International Physics Olympiad.
- Help a local school conduct its Science Fair (e.g., volunteer to be judges).

### Service to the Physics and astronomy Department (making your chapter indispensable):

Conduct problem-solving sessions for groups of students in introductory physics courses.

- Offer a tutoring service for individual students who come by your SPS room.
- Carry out a course evaluation survey for the physics and/or astronomy department.
- Prepare bulletin boards and window displays illustrating physical phenomena, historical personalities, the influence of physics and astronomy in society, the department’s programs and personnel.
- Host a SPS Zone meeting.
- Publish a semi-annual chapter and departmental newsletter. This can be sent to alumni, prospective students, donors, university administrators, students’ parents and friends, colleagues in other institutions, and other friends of the department with whom you wish to maintain contact.
- Maintain a chapter and departmental scrapbook.
- Collect, organize, and post information about graduate schools. Your department chair receives loads of this stuff all the time and would appreciate having someone take the task of dealing with it off their hands.

### Social Events:

- Hold a student-faculty picnic at the beginning of the academic year, and another at the end of the academic year.
- Have a chapter camping trip.
- Have parties at holiday times.
- After a big exam, have a “decompression party” at a faculty member’s house.
- Plan to have a dignified Sigma Pi Sigma induction ceremony every year. An evening banquet with a speaker, presented with class and engaging all the department, can become a high point of the departmental calendar.

### Membership Promotion:

- Participate in Freshman Orientation Programs that acquaint new students with campus organizations.
- Have SPS members visit introductory physics classes and make a five-minute presentation.
- Involve interested freshmen in all SPS activities. Involve them first; and then membership will take care of itself.
- If the department has a graduate program, invite the graduate students to all SPS functions, and to join
- SPS and hold offices. Indeed, in some universities, the graduate students are more active in SPS than the undergraduates!
- Place prospective majors on your mailing list during new student recruitment. The accomplishments of your chapter can be a tremendous asset for recruitment.
- Give a SPS membership as a door prize as part of the drive for new members.

## Fundraising:

- Design and sell chapter T-shirts or coffee mugs. The SPS Office can provide logos and assistance.
- Collect used textbooks, journals and calculators and have a sale. Faculty usually have a few items to donate.
- Have a garage sale.
- Ask the department chair if the SPS can sell coffee and donuts.
- Bake cookies and sell them.
- Use your connections with local businesses to obtain items to raffle.

Many SPS activities can be supported with a small budget funded by local chapter dues. As a campus organization, the SPS chapter may be eligible to receive an allocation from the Student Government Association upon the submission of the necessary paperwork and budget. Often the physics department will assist the chapter with transportation and mailing expenses. Travel can be done cheaply if members split car expenses and use sleeping bags at the destination (assuming the host is willing).

## Conducting SPS Chapter Meetings and Building your Chapter

The personality of a local SPS Chapter is as unique as the individuals that comprise the chapter. Each chapter has the ability to determine the frequency of their chapter meetings and the content/activities conducted within their chapter meetings. The best practices for chapter meetings are to incorporate activities and events that foster a sense of community and culture for your local department. SPS is whatever it needs to be and we celebrate these variations.

The below list includes great ideas for things that local chapters can do to help foster community and culture and can form the basis for the agendas of your chapter meetings:

### Encouraging National Membership

SPS leaders are encouraged to work to get the entire local chapter registered as dues paying SPS members. The benefits are many. For one, all the members in the chapter have a common set of knowledge about SPS programs and opportunities. This builds community and energy for participating in the larger organization. Many chapters have SPS membership as a requirement for travel with the chapter, and find creative ways for fundraising to pay for individual or chapter dues. There is a reduced rate if chapter members sign up as a group or as a chapter. Information pertaining to the membership discounts

can be found here [spsnational.org/about/membership](https://spsnational.org/about/membership).

### Encourage Participation in SPS Programs

Find ways to encourage chapter members to participate in SPS programs and opportunities. This is another way to make the point that no matter what the size of the chapter, SPS members are a part of something bigger. Award winners and scholarship winners are recognized in SPS publications, both in print and electronically. For departments, these awards can serve as recruitment and retention tools, as they demonstrate the engagement and success of students and faculty mentors in the department. Students should also be encouraged to attend regional and national AIP member society and professional meetings. Students should be encouraged to present research at these scientific meetings, but should be encouraged and supported to attend even if not presenting to become introduced to the professional community.

### Participate in Tours, Field Trips, and Professional Speakers

One way to introduce students to the professional community is through exposure. Chapters are encouraged to arrange field trips, participate in tours of nearby national labs, industrial companies, hospitals, or other areas where people practice the physical sciences. Bringing speakers to campus (whether physically or virtually) to speak with students is a huge benefit to students that can help connect them to the larger physics and astronomy community.

### Connection to Your Local Campus and Community Beyond

In many departments, the SPS chapter serves as a vehicle for recruitment and retention. Your chapter can create a number of activities that provide a sense of community for the physics and astronomy department and those interested in physics and astronomy. Example activities include organizing a physics and astronomy demo fair for local primary and secondary schools, to sending chapter officers to classrooms to recruit new SPS members, to hosting banquets for incoming underclassmen and graduating upperclassmen.

SPS chapters are encouraged to interact with the larger campus community, so that physics and astronomy is not just something done in the physics and astronomy building. Help others get to learn about physics as well! SPS chapters can plan joint fundraising activities with other student organizations, hold picnics for faculty and students, plan career fairs with other STEM departments, etc.





# Yearly Calendar for SPS Chapters

There is no standard program for a SPS chapter because each chapter is unique. This calendar provides a guide for activities and programs your chapter may wish to consider throughout the academic year. Not every chapter will choose to engage in every element. Choose those that work best for you!

## BEGINNING OF SEMESTER:

- Membership Drive: Participate in Freshman Orientation Program to acquaint freshmen with SPS. Have a booth to encourage bulk registration for national membership.
- Put up SPS posters and meeting announcements
- Request the SPS outreach kit (SOCK)
- Visit introductory physics classes
- Plan biweekly meetings for the year

### SEPTEMBER:

- Kick-off social (Ex. faculty-student picnic or other get-acquainted event)
- Fundraisers: Sell books donated by faculty, used textbooks, bumper stickers, chapter-designed T-shirts, raffle tickets, car wash, etc.
- Plan for big events and outreach: Marsh W. White Award, Future Faces of Physics Award, and Sigma Pi Sigma Undergraduate Research Award proposals, brainstorm outreach events
- Post fall mailing materials
- Collect dues and fill out group membership forms for discount

### OCTOBER:

- Talk by outside lecturer at meeting
- Bad physics movie night
- Attend SPS Zone Meeting or plan to attend regional meeting
- Arrange to attend a national research meeting
- Hold a fundraiser for PhysCon
- Halloween-themed physics and astronomy event
- Check out SPS outreach demos or create your own to upload on the website
- Ask your AZC\* and ZC\* about the next zone meeting

### NOVEMBER:

- Submit chapter proposal for Marsh W. White Award & Future Face of Physics Award
- Submit student proposals for SPS Chapter Research Award
- Host an outside speaker/lecturer at monthly meeting
- Tour of physics/astronomy research laboratory (industrial, government, or academic)
- Submit chapter proposal for Sigma Pi Sigma Chapter Project Award
- Thanksgiving potluck

\* AZC/ZC are your associate zone councilor and zone councilor that represent your zone at the SPS level.



## DECEMBER:

- Business meeting: Nomination of chapter member as candidate for associate zone councilor
- Program planning for spring social event (set date, budget, etc.)
- Host a year-end party
- Identify a spring tour at a nearby lab or facility

## JANUARY:

- Submit student applications for SPS summer internships
- Plan chapter road trip
- Prepare a member outreach event
- Hold fundraising event for spring events

## FEBRUARY:

- Arrange a talk by faculty member at monthly meeting
- Host a bad physics movie night
- Submit SPS Scholarship applications
- Apply for SPS and  $\Sigma\pi\Sigma$  service awards

## MARCH:

- Talk by outside lecturer at monthly meeting
- Tour of physics or astronomy research laboratory (industrial, government, or academic)
- Sponsor physics department open house
- Business meeting: Cast chapter vote in SPS elections
- Attend SPS zone meeting
- Submit SPS Scholarship and Outstanding Undergraduate Research applications, and Outstanding Chapter Advisor nominations
- Submit research and scholarly reports for publication in JURP

## APRIL:

- Sigma Pi Sigma reception, talk, and induction banquet
- Talk by outside lecturer at monthly meeting
- Business meeting: Election of chapter officers for next academic year, preliminary planning for chapter program for next academic year
- Submit new officers to SPS database
- Business meeting: Nomination of chapter officers for next academic year
- Find a creative way to thank and celebrate your SPS advisor

## MAY:

- Large social event: faculty-student picnic and soccer game
- Submit Chapter Report before everyone leaves for the summer and apply for Blake Lilly Prize
- Plan a fall meeting date to start off the new year
- Celebrate graduating seniors
- Develop goals for next year
- Email the new AZC and ZC to introduce your SPS chapter and officers



# Sample SPS Chapter Bylaws

[spsnational.org/about/governance/sample-bylaws-chapters](https://spsnational.org/about/governance/sample-bylaws-chapters)

(Name of Institution) Chapter of the Society of Physics Students

## ARTICLE I. NAME

The name of this organization shall be “The (NAME OF INSTITUTION) Chapter of the Society of Physics Students”.

## ARTICLE II. OBJECTIVES

The purpose of this Chapter shall be the advancement and diffusion of knowledge of physics and astronomy, the encouragement and diffusion of knowledge of physics and astronomy, the encouragement of interest in physics and astronomy throughout the academic and local communities, and the introduction of students to the professional community.

## ARTICLE III. MEMBERSHIP

### Section I. Society of Physics and astronomy Students Membership

Membership in this Society of Physics and Astronomy Students Chapter shall be open to all individuals interested in physics and astronomy.

### \*\*Section II. Sigma Pi Sigma Membership

Membership in Sigma Pi Sigma, the physics and astronomy honor society included within this Society of Physics Students Chapter, shall be based upon character and academic and professional attainments and is not restricted to physics and astronomy majors. Election to Sigma Pi Sigma members from among those candidates presented by the Sigma Pi Sigma nominating committee appointed by the chapter Advisor.

Clause 1. For undergraduate students in physics, astronomy, or related fields, the minimum requirements for Sigma Pi Sigma membership within this Chapter shall be as follows:

(A) All members-elect shall have completed at least the equivalent of three semesters (five quarters) of full-time college work.

(B) All members-elect shall have completed at least three semester (five quarters) courses in physics or astronomy, each of at least three credit hours, which may be credited

toward a physics major.

(C)\*\*\* All members-elect shall rank in the upper one third of their college class.

(D)\*\*\* All members-elect shall have attained at least a 3.0 grade point average on a 4.0 system for physics and astronomy courses and for cumulative course grades in all courses.

Clause 2. For graduate students in physics or related fields, all members-elect either (a) shall meet the requirements for undergraduate members-elect, based upon their undergraduate records, or (b) shall have completed at least one year of graduate work, meeting departmental standards for satisfactory progress towards an advanced degree.

Clause 3. For faculty members, research staff members, and other qualified individuals, who are in physics or related fields, election to membership shall be based upon their professional attainments.

## ARTICLE IV. OFFICERS

### Section I. Chapter Officers

The officers of the Chapter shall be a President, a Vice President, a Secretary, and a Treasurer; succession shall be in accordance with this order. Any two of the last three offices may be combined. These officers shall perform the duties prescribed by these bylaws and by the parliamentary authority adopted by this Chapter.

### Section II. Elections

Officers shall be elected at a scheduled meeting in April of each year. Nominations shall be by open nomination at a meeting in the previous month. The election shall be by closed ballot. Officers-elect shall assume their officers immediately following the election and shall hold office for one year or until their successors are duly elected.

### Section III. Sigma Pi Sigma Responsibility

Upon the installation of a Sigma Pi Sigma Chapter within the Society of Physics Students Chapter, one of the officers, who is a Sigma Pi Sigma member, and the Chapter Advisor shall be given specific responsibility of the affairs of the Sigma Pi Sigma Chapter.

## ARTICLE V. CHAPTER ADVISOR

The Chapter Advisor shall be a faculty member appointed by the Chairman of the Physics and/or Astronomy Department, after

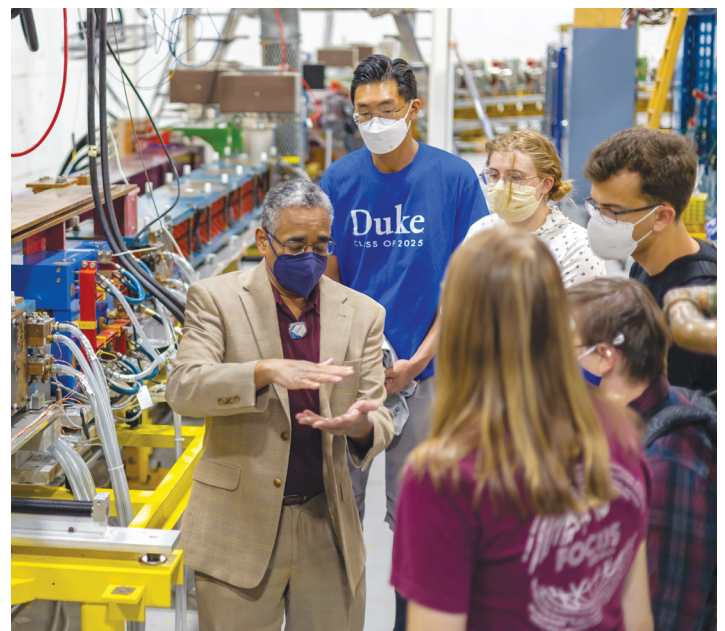

consultation with the Chapter Officers. The Chapter Advisor shall provide liaison among the Chapter, the Physics Department, and the National Office of the Society of Physics Students. The Chapter Advisor will supply counseling to the Chapter, furnish continuity of experience in Chapter operations, and provide long-range perspective to insure departmental interest in and support of the Society of Physics Students. The Chapter Advisor shall assist the Secretary in furnishing the National Office with the required data and shall assist the Treasurer in transmitting fees and dues to the National Office.

#### **ARTICLE VI. MEETINGS**

Regular meetings shall be held monthly as determined by the officers. Special meetings may be called by the President or Vice-President. There shall be at least six meetings per year.

#### **ARTICLE VII. DUES**

Regular meetings shall be held monthly as determined by the officers. Special meetings may be called by the President or Vice-President. There shall be at least six meetings per year.

#### **ARTICLE VIII. PARLIAMENTARY AUTHORITY**

The rules contained in the current edition of Robert's Rules of Order Newly Revised shall govern the Chapter in all cases to which they are applicable and in which they are not inconsistent with these bylaws and any special rules of order the Chapter may adopts.

#### **ARTICLE IX. AMENDMENT OF BYLAWS**

These bylaws may be amended by a two-thirds vote, provided that the amendment shall have been proposed at least one meeting previous to the time of vote. Such amendments shall conform to the regulations established by the National Constitution of the Society of Physics Students.

\*Variations in bylaws, as required to suit local circumstances, are acceptable providing they agree with the spirit of the National Constitution of the Society of Physics Students.

\*\*Article III, Section II and Article IV, Section III must be included by, and only by, institutions eligible to elect members into Sigma Pi Sigma (accredited, four-year institutions offering at least a bachelor's degree in physics or astronomy).

\*\*\*The requirement in Article III, Section II, Clause I(D) is not a constitutional requirement. However, it is usually easier to obtain a

grade point average from the Recorder's Office than a class rank. Provision should be made to periodically check with the Recorder's Office that the specified GPA also satisfies Article III, Section II, Clause 1(C), which requires members-elect to rank in the upper one third of their college class and which is a minimum requirement specified by the National Constitution.

## **Seven Roles of SPS in the Physics and Astronomy Community**

### **1. Undergraduate Research as a Teaching Tool**

Undergraduate research teaches lessons and fosters skills that course work alone often cannot reach. The mission of undergraduate research is not the research itself; it is the growth in self-confidence and experience for the undergraduate. The product of undergraduate research is not necessarily a publication; it is the transformation of the student from being merely a taker of courses into a contributing member of the professional community.

Through SPS Zone Meetings, the SPS Observer, online journal publications, and various programs, SPS launches students into their professions. creates an entrée into the profession through undergraduate research experience opportunities.

### **2. Physics Outreach to K-12 Students and the General Public**

Until every physicist is taking demonstrations to a local grade school at least once a year and working as colleagues with the teachers there to promote science literacy, the physics and Astronomy community is not doing everything possible to foster the public's appreciation of science. There are over 820 SPS chapters in the United States and internationally. Almost every one of them is near several elementary and secondary schools. SPS can take the lead in physics and Astronomy outreach.

### **3. Multiple Career Options are Open to Those With a Degree in Physics and astronomy**

There is no major that guarantees a student a job. Therefore, students are well-advised to pursue a course of study that maximizes their options. AIP has both anecdotal and statistical evidence that graduates with a Bachelor's degree in physics and



astronomy do well in a wide spectrum of careers, and not only in the traditional track that proceeds through physics and astronomy graduate school. Physics alumni are engineers, computer scientists, insurance actuaries, teachers, managers, patent lawyers, financial analysts, politicians, mathematicians, statisticians, etc. They have made careers in business, chemistry, meteorology, geology, biophysics, medicine, and many other fields. Peruse the SPS Careers Resources featuring profiles of physicists, careers information and statistics, and explore career opportunities. Find out more here: [spsnational.org/career-resources](https://spsnational.org/career-resources).

#### 4. Recruitment and Retention Tool for the Department

A student may come to a particular physics department for a pre-engineering program. But once engaged in the active SPS chapter by participating in undergraduate research, attending professional meetings, being involved in physics and astronomy outreach to the local schools, and forming a network of like-minded colleagues, the student may stay with the department to major or minor in physics and astronomy. This is especially true in light of the many career options that are open to someone with a bachelor's degree in physics. In an environment where all academic departments are under pressure to maintain high enrollments, an active SPS chapter provides a definite advantage to the physics and astronomy department.

#### 5. SPS and Sigma Pi Sigma Members are the "Friends of Physics and astronomy" throughout Society

SPS exists to create a sense of community throughout the undergraduate physics world. SPS is the only institutionalized structure that the physics community has for engaging not only the student physicist, but the student friend of physics and astronomy that may major in another field. Sigma Pi Sigma is the only institutionalized structure that the and Astronomy community has for engaging those

many persons who have excelled in physics and then go forth into all walks of life, and pursue careers that include but are not limited to those of traditional physics.

Given the present lack of science appreciation in society, and the uncertain future of public support for basic research and science education, the SPS and Sigma Pi Sigma communities can play a large role in promoting and advocating on behalf of STEM research and support.

#### 6. SPS as an Introduction to the Other Professional Physical Science Societies

SPS members who join as an undergraduate may chose free membership in two of the ten AIP Member Societies. Many of these societies offer resources and benefits that will support them as they pursue professional careers.

#### 7. Training for Leadership

Twenty or thirty years from now, students who are now members of SPS and who are planning careers in traditional physics will be the leaders of the physics and astronomy institutions and the culture of physics and astronomy. Students who are now members of SPS but who go into other fields will similarly be leading the way in their circles of influence. The physics establishment, and the establishments of potential friends of physics and astronomy, will be theirs to shape, for better or worse.

Through SPS activities, the student's professional development, communication skills, leadership qualities, and professional networking are enhanced in ways that cannot be realized in coursework alone. SPS and Sigma Pi Sigma have unique and important roles to fulfill in shaping the culture of physics and its related disciplines.



# PART III.

## SIGMA PI SIGMA ( $\Sigma\Pi\Sigma$ ), THE PHYSICS AND ASTRONOMY HONORS SOCIETY

Sigma Pi Sigma is the physics and astronomy honors society. Chapters are restricted to colleges and universities of recognized standing that offer a physics and astronomy major and students that are selected to join must meet a high standard of scholarship and outstanding achievement. Sigma Pi Sigma is an excellent source of support for departments and the students. It is highly encouraged to make Sigma Pi Sigma inductees, members, and alumni part of the larger department family by inviting them to talks, including them in departmental ceremonies, and inviting them to interact with or mentor current students. SPS can assist with connecting you to alumni of your chapter.

### $\Sigma\Pi\Sigma$ Membership & Benefits

Membership is not limited to undergraduates. Graduate students, faculty members, and accomplished scientists from all careers are welcome in Sigma Pi Sigma. While local chapters set standards for prospective members, the minimum national standards specify that undergraduates must be in the upper one-third of their class in general scholarship, have completed at least three semesters or five quarters of full-time college course work, and have completed at least three semesters or five quarter courses in physics that can be credited toward a physics baccalaureate degree. Graduate students are eligible

for induction upon completing one year of study with satisfactory progress. Students who are not physics majors can be elected, provided that they meet the standards and have demonstrated an interest in physics.

A  $\Sigma\Pi\Sigma$  chapter is highly encouraged to induct qualified students and faculty members from nearby colleges that do not have a chapter. Physicists and astronomers in industry, government laboratories, and science educators can be elected by chapters on the basis of their professional record.

### Lifetime Membership

Induction into Sigma Pi Sigma includes a lifetime membership. An entrance fee for \$54.00 is paid at the time of induction. This fee includes a one-year membership in the Society of Physics Student (SPS), an official  $\Sigma\Pi\Sigma$  pin, membership certificate, a lifetime subscription to Radiations magazine, and an official membership card. There are no annual dues to Sigma Pi Sigma or special assessment beyond the original entrance fee. Sigma Pi Sigma members can also purchase regalia, including honor cords, stoles, and tassels, to be worn in commencement ceremonies and other academic events through the SPS Store: [sigmapisigma.org/sigmapisigma/induction-center/insignia-regalia](http://sigmapisigma.org/sigmapisigma/induction-center/insignia-regalia).



## [www.spsnational.org/pion-resources](http://www.spsnational.org/pion-resources)

Sigma Pi Sigma members are encouraged to stay engaged with the society throughout their professional careers through the Pion Portal. The Pion Portal aims to engage the Sigma Pi Sigma community to help physics students develop skills, insight, and relationships that will prepare and empower them to make the best, most effective career decisions upon graduation. Whether you are a student or an alumnus, we encourage you to get involved with the Sigma Pi Sigma community through the Pion Portal. Check out the resources below!

Want to volunteer? Email us at [sigmapisigma@aip.org](mailto:sigmapisigma@aip.org) or give us a call at 301-209-3007 so that we can connect you with a local department or service opportunity.

### Encouragement

By honoring high achievement in physics and upholding high standards for election into Sigma Pi Sigma, the Society provides an incentive for all physics students to rise to excellence. The society is a source of encouragement to all students who study physics, whatever the ultimate level of performance achieved by the individual. Such encouragement ranges from promoting physics interest and science literacy in the general public, to challenging those who are pondering their potential for earning higher degrees. Sigma Pi Sigma urges its members to demonstrate this encouragement through personal service.



### Service

With the recognition of accomplishment comes a responsibility to service at all levels. Nationally, Sigma Pi Sigma members can serve by helping to work for sound national science policies. Locally, Sigma Pi Sigma members can serve in community science education projects and in mentoring individual students. Through our member's personal initiative, members of the local community can learn more about physics and witness the high standards of Sigma Pi Sigma membership. Our colleges, universities, and our Society know that when we become alumni, because we respect the personal struggle for excellence, we will support the generations of students that follow. When the experience of Sigma Pi Sigma members is placed at the service of others, at any level, then Sigma Pi Sigma touches more lives than may be counted by the number of its members.

### Fellowship

The criterion of Sigma Pi Sigma membership is proven excellence in physics. Sigma Pi Sigma members represent many generations of experience and wisdom that can be focused on the matters that unite us.

In Sigma Pi Sigma, there are no professional boundaries. One finds all professions represented in the Sigma Pi Sigma membership. There are many practicing physicists among Sigma Pi Sigma members, but excellence in physics has opened many career options to our members. Sigma Pi Sigma unites a diverse group of exceptional people who have shared in the culture and traditions of physics. With the common thread of this shared background running through so rich a diversity of generations and professions, Sigma Pi Sigma promotes a spirit of community among its members and encourages them to offer their collective wisdom and perspectives in the service of the larger society.



## Inductions and the Ceremony

Chapters are highly encouraged to highlight the induction of new members by hosting an induction ceremony. The ceremony is an opportunity to honor those that have excelled academically and to bring positive attention to the program and department. The traditions of each chapter are unique, with each school carrying out this important recognition of excellence and department culture in their own way. Inductions can happen any time of year, with most chapters choosing Spring.

To celebrate, most schools invite campus administrators, friends, inductee relatives, and Sigma Pi Sigma Alumni to join in the welcoming of the newest inductees. This sharing of the experience is also a fantastic opportunity to showcase the department and connect with alumni. There are resources for the induction ceremony (including videos, Powerpoint presentations, detailed scripts, and ceremony format suggestions) located here: [sigmapisigma.org/sigmapisigma/induction-center](https://sigmapisigma.org/sigmapisigma/induction-center).

The SPS office processes new Sigma Pi Sigma memberships electronically. Once students (or departments) have paid and are registered as new inductees, personalized induction materials are provided to chapter advisors for the induction ceremony. Please allow for 10 full business days for processing to avoid expedited shipping charges. For specific details, visit the virtual green folder: [sigmapisigma.org/sigmapisigma/induction-center](https://sigmapisigma.org/sigmapisigma/induction-center).

## Department Benefits

While membership within Sigma Pi Sigma benefits individual members, chapters help departments develop and maintain a healthy community.

- SPS can connect you with Sigma Pi Sigma members who are alumni, often long after they have graduated from your department.
- Through our Alumni Engagement Program and national membership network, we can work with you with speakers from a broad array of career pathways.
- Sigma Pi Sigma can provide students, faculty, and alumni with community service opportunities that span the globe.
- Membership within Sigma Pi Sigma can be extended to those that serve a department's students, faculty, and local community.
- Your department can honor alumni and those that strengthen your department through Sigma Pi Sigma service awards and honorary membership.
- The National Office can provide resources, advice, and connections to the broader Physical Sciences community.



## Listing of SPS Chapters with Installation Dates

1. Adelphi University, Garden City, NY – April 22, 1968
2. Alabama, University of, Tuscaloosa, AL – April 22, 1968
3. Albion College, Albion, MI – April 22, 1968
4. Alma College, Alma, MI – April 22, 1968
5. American International College, Springfield, MA – April 22, 1968
6. Andrews University, Berrien Springs, MI – April 22, 1968
7. Angelo State University, San Angelo, TX – April 22, 1968
8. Arizona State University, Tempe, AZ – April 22, 1968
9. Arizona, University of, Tucson, AZ – April 22, 1968
10. Central Arkansas, University of, Conway, AR – April 22, 1968
11. Arkansas, University of, Fayetteville, AR – April 22, 1968
12. Auburn University, Auburn, AL – April 22, 1968
13. Augustana College, Rock Island, IL – April 22, 1968
14. Augustana College, Sioux Falls, SD – April 22, 1968
15. Aurora College, Aurora, IL – April 22, 1968
16. Ball State University, Muncie, IN – April 22, 1968
17. Bates College, Lewiston, ME – April 22, 1968
18. Baylor University, Waco, TX – April 22, 1968
19. Belknap College, Center Harbor NH – April 22, 1968
20. Beloit College, Beloit, WI – April 22, 1968
21. Berea College, Berea, KY – April 22, 1968
22. Bloomsburg University, Bloomsburg, PA – April 22, 1968
23. Boston College, Chestnut Hill, MA – April 22, 1968
24. Boston State College, Boston, MA – April 22, 1968
25. Bowdoin College, Brunswick, ME – April 22, 1968
26. Bowling Green State University, Bowling Green, OH – April 22, 1968
27. Bridgeport, University of, Bridgeport, CT – April 22, 1968
28. Bridgewater College, Bridgewater, VA – April 22, 1968
29. Brigham Young University, Provo, UT – April 22, 1968
30. Brooklyn College of the CUNY, Brooklyn, NY – April 22, 1968
31. Bucknell University, Lewisburg, PA – April 22, 1968
32. C.W. Post College of Long Island University, Greenvale, NY – April 22, 1968
33. California State University-Fullerton, Fullerton, CA – April 22, 1968
34. California State University-Long Beach, Long Beach, CA – April 22, 1968
35. California State University-Los Angeles, Los Angeles, CA – April 22, 1968
36. California Polytechnic State University-San Luis Obispo, San Luis Obispo, CA – April 22, 1968
37. California-Davis, University of, Davis, CA – April 22, 1968
38. California-Los Angeles, University of, Los Angeles, CA – April 22, 1968
39. California-Santa Barbara, University of, Santa Barbara, CA – April 22, 1968
40. Canisius College, Buffalo, NY – April 22, 1968
41. Carnegie-Mellon University, Pittsburgh, PA – April 22, 1968
42. Carson-Newman College, Jefferson City, TN – April 22, 1968
43. Case Western Reserve University, Cleveland, OH – April 22, 1968
44. Centenary College of Louisiana, Shreveport, LA – April 22, 1968
45. Central State University, Edmond, OK – April 22, 1968
46. Christian Brothers College, Memphis, TN – April 22, 1968
47. Cincinnati, University of, Cincinnati, OH – April 22, 1968
48. Citadel, The, Charleston, SC – April 22, 1968
49. City College of the CUNY, New York, NY – April 22, 1968
50. Clark University, Worcester, MA – April 22, 1968
51. Clarkson University, Potsdam, NY – April 22, 1968
52. Clemson University, Clemson, SC – April 22, 1968
53. Cleveland State University, Cleveland, OH – April 22, 1968
54. Colby College, Waterville, ME – April 22, 1968
55. Colgate University, Hamilton, NY – April 22, 1968
56. Colorado School of Mines, Golden, CO – April 22, 1968
57. Colorado State University, Fort Collins, CO – April 22, 1968
58. Colorado, University of, Boulder, CO – April 22, 1968
59. Connecticut, University of, Storrs, CT – April 22, 1968
60. Cooper Union, The, New York, NY – April 22, 1968
61. Creighton University, Omaha, NE – April 22, 1968
62. Dartmouth College, Hanover, NH – April 22, 1968
63. Davidson College, Davidson, NC – April 22, 1968
64. Dayton, University of, Dayton, OH – April 22, 1968
65. Delaware, University of, Newark, DE – April 22, 1968
66. Denison University, Granville, OH – April 22, 1968
67. Denver, University of, Denver, CO – April 22, 1968
68. De Paul University, Chicago, IL – April 22, 1968
69. DePauw University, Greencastle, IN – April 22, 1968
70. Detroit, University of, Detroit, MI – April 22, 1968
71. Dickinson College, Carlisle, PA – April 22, 1968
72. Drake University, Des Moines, IA – April 22, 1968
73. Drew University, Madison, NJ – April 22, 1968
74. Drexel University, Philadelphia, PA – April 22, 1968
75. Duke University, Durham, NC – April 22, 1968
76. Duquesne University, Pittsburgh, PA – April 22, 1968
77. East Carolina University, NC – April 22, 1968
78. Eastern Illinois University, IL – April 22, 1968
79. Eastern Kentucky University, Richmond, KY – April 22, 1968
80. Emmanuel College, Boston, MA – April 22, 1968
81. Emory University, Atlanta, GA – April 22, 1968
82. Evansville, University of, Evansville, IN – April 22, 1968
83. Fairfield University, Fairfield, CT – April 22, 1968
84. Fairleigh Dickinson University, Teaneck, NY – April 22, 1968
85. Florida Institute of Technology, Melbourne, FL – April 22, 1968
86. Florida Southern College, Lakeland, FL – April 22, 1968
87. Florida State University, Tallahassee, FL – April 22, 1968
88. Florida, University of, Gainesville, FL – April 22, 1968
89. Fordham University, Bronx, NY – April 22, 1968
90. Fort Hays State University, Hays, KS – April 22, 1968
91. Franklin & Marshall College, Lancaster, PA – April 22, 1968
92. Gannon University, Erie, PA – April 22, 1968
93. George Washington University, Washington, DC – April 22, 1968
94. Georgetown University, Washington, DC – April 22, 1968
95. Georgia Institute of Technology, Atlanta, GA – April 22, 1968
96. Georgia, University of, Athens, GA – April 22, 1968
97. Gettysburg College, Gettysburg, PA – April 22, 1968
98. Greenville College, Greenville, IL – April 22, 1968
99. Grinnell College, Grinnell, IA – April 22, 1968
100. Grove City College, Grove City, PA – April 22, 1968
101. Hanover College, Hanover, IN – April 22, 1968
102. Hartwick College, Oneonta, NY – April 22, 1968
103. Harvard University, Cambridge, MA – April 22, 1968
104. Harvey Mudd College, Claremont, CA – April 22, 1968
105. Herbert H. Lehman College of the CUNY, Bronx, NY – April 22, 1968
106. Hofstra University, Hempstead, NY – April 22, 1968
107. Holy Cross, College of the, Worcester, MA – April 22, 1968
108. Houston, University of, Central Campus, Houston, TX – April 22, 1968
109. Howard University, Washington, DC – April 22, 1968
110. Humboldt State University, Arcata, CA – April 22, 1968
111. Hunter College of the CUNY, New York, NY – April 22, 1968
112. Idaho State University, Pocatello, ID – April 22, 1968
113. Idaho, University of, Moscow, ID – April 22, 1968
114. Illinois Institute of Technology, Chicago, IL – April 22, 1968
115. Illinois State University, Normal, IL – April 22, 1968
116. Indiana Institute of Technology, Fort Wayne, IN – April 22, 1968
117. Indiana State University, Terre Haute, IN – April 22, 1968
118. Indiana University, Bloomington, IN – April 22, 1968
119. Indiana University of Pennsylvania, Indiana, PA – April 22, 1968
120. Iona College, New Rochelle, NY – April 22, 1968
121. Iowa State University, Ames, IA – April 22, 1968
122. Jacksonville University, Jacksonville, FL – April 22, 1968
123. John Carroll University, University Heights, OH – April 22, 1968
124. Johns Hopkins University, Baltimore, MD – April 22, 1968



125. Pittsburg State University, Pittsburg, KS – April 22, 1968
126. Emporia State University, Emporia, KS – April 22, 1968
127. Kansas State University, Manhattan, KS – April 22, 1968
128. Kansas, University of, Lawrence, KS – April 22, 1968
129. Kansas Wesleyan University, Salina, KS – April 22, 1968
130. Kent State University, Kent, OH – April 22, 1968
131. Kentucky, University of, Lexington, KY – April 22, 1968
132. Lafayette College, Easton, PA – April 22, 1968
133. Lake Forest College, Lake Forest, IL – April 22, 1968
134. Lamar University, Beaumont, TX – April 22, 1968
135. La Salle College, Philadelphia, PA – April 22, 1968
136. Lebanon Valley College, Annville, PA – April 22, 1968
137. Lehigh University, Bethlehem, PA – April 22, 1968
138. Le Moyne College, Syracuse, NY – April 22, 1968
139. Linfield College, McMinnville, OR – April 22, 1968
140. Loma Linda University, Riverside, CA – April 22, 1968
141. Long Island University, Brooklyn, NY – April 22, 1968
142. Louisiana State University, Baton Rouge, LA – April 22, 1968
143. New Orleans, University of, New Orleans, LA – April 22, 1968
144. Louisiana Tech University, Ruston, LA – April 22, 1968
145. Louisville, University of, Louisville, KY – April 22, 1968
146. Massachusetts-Lowell, University of, Lowell, MA – April 22, 1968
147. Loyola College, Baltimore, MD – April 22, 1968
148. Loyola Marymount University, Los Angeles, CA – April 22, 1968
149. Loyola University of Chicago, Chicago, IL – April 22, 1968
150. Loyola University of New Orleans, New Orleans, LA – April 22, 1968
151. Lycoming College, Williamsport, PA – April 22, 1968
152. McMurry College, Abilene, TX – April 22, 1968
153. Maine, University of, Orono, ME – April 22, 1968
154. Manchester College, North Manchester, IN – April 22, 1968
155. Manhattan College, Bronx, NY – April 22, 1968
156. Marshall University, Huntington, WV – April 22, 1968
157. Maryland-College Park, University of, College Park, MD – April 22, 1968
158. Massachusetts Institute of Technology, Cambridge, MA – April 22, 1968
159. Memphis, University of, Memphis, TN – April 22, 1968
160. Merrimack College, North Andover, MA – April 22, 1968
161. Miami University, Oxford, OH – April 22, 1968
162. Michigan State University, East Lansing, MI – April 22, 1968
163. Michigan Technological University, Houghton, MI – April 22, 1968
164. Minnesota, University of, Minneapolis, MN – April 22, 1968
165. Mississippi State University, Mississippi, MS – April 22, 1968
166. Missouri-Columbia, University of, Columbia, MO – April 22, 1968
167. Missouri-Rolla, University of, Rolla, MO – April 22, 1968
168. Monmouth College, West Long Branch, NJ – April 22, 1968
169. Morehead State University, Morehead, KY – April 22, 1968
170. Morgan State University, Baltimore, MD – April 22, 1968
171. Morningside College, Sioux City, IA – April 22, 1968
172. Muhlenberg College, Allentown, PA – April 22, 1968
173. Murray State University, Murray, KY – April 22, 1968
174. Muskingum College, New Concord, OH – April 22, 1968
175. Nebraska Wesleyan University, Lincoln, NE – April 22, 1968
176. Nevada-Reno, University of, Reno, NV – April 22, 1968
177. New Mexico State University, Las Cruces, NM – April 22, 1968
178. New Mexico, University of, Albuquerque, NM – April 22, 1968
179. New York Institute of Technology, Old Westbury, NY – April 22, 1968
180. New York Institute of Technology, New York, NY – April 22, 1968
181. New York University, University Heights, Bronx, NY – April 22, 1968
182. New York University, New York, NY – April 22, 1968
183. Niagara University, NY – April 22, 1968
184. North Carolina A&T State University, Greensboro, NC – April 22, 1968
185. North Carolina State University, Raleigh, NC – April 22, 1968
186. North Carolina-Chapel Hill, University of, Chapel Hill, NC – April 22, 1968
187. North Dakota State University, Fargo, ND – April 22, 1968
188. North Dakota, University of, Grand Forks, ND – April 22, 1968
189. North Georgia College, Dahlonega, GA – April 22, 1968
190. North Texas State University, Denton, TX – April 22, 1968
191. Northeastern University, Boston, MA – April 22, 1968
192. Northern Illinois University, DeKalb, IL – April 22, 1968
193. Notre Dame College, South Euclid, OH – April 22, 1968
194. Oakland University, Rochester, MI – April 22, 1968
195. Occidental College, Los Angeles, CA – April 22, 1968
196. Ohio State University, Columbus, OH – April 22, 1968
197. Ohio University, Athens, OH – April 22, 1968
198. Oklahoma City University, Oklahoma City, OK – April 22, 1968
199. Oklahoma State University, Stillwater, OK – April 22, 1968
200. Oklahoma, University of, Norman, OK – April 22, 1968
201. Old Dominion University, Norfolk, VA – April 22, 1968
202. Olivet Nazarene University, Kankakee, IL – April 22, 1968
203. Oregon State University, Corvallis, OR – April 22, 1968
204. Widener College, Chester, PA – April 22, 1968
205. Pacific Lutheran University, Tacoma, WA – April 22, 1968
206. Pacific Union College, Angwin, CA – April 22, 1968
207. Pacific, University of the, Stockton, CA – April 22, 1968
208. Texas-Pan American, University of, (Pan American University), Edinburg, TX – April 22, 1968
209. Pennsylvania State University, University Park, PA – April 22, 1968
210. Pittsburgh, University of, Pittsburgh, PA – April 22, 1968
211. Polytechnic Institute of New York, Brooklyn, NY – April 22, 1968
212. Providence College, Providence, RI – April 22, 1968
213. Puget Sound, University of, Tacoma, WA – April 22, 1968
214. Purdue University, West Lafayette, IN – April 22, 1968
215. Rensselaer Polytechnic Institute, Troy, NY – April 22, 1968
216. Rhode Island, University of, Kingston, RI – April 22, 1968
217. Rice University, Houston, TX – April 22, 1968
218. Richmond, University of, Richmond, VA – April 22, 1968
219. Ripon College, Ripon, WI – April 22, 1968
220. Roanoke College, Salem, VA – April 22, 1968
221. Rose-Hulman Institute of Technology, Terre Haute, IN – April 22, 1968
222. Rutgers University-New Brunswick, Piscataway, NJ – April 22, 1968
223. Rutgers University, Camden College of Arts & Sciences, Camden, NJ – April 22, 1968
224. Rutgers University, Newark College of Arts & Sciences, Newark, NJ – April 22, 1968
225. St. Ambrose College, Davenport, IA – April 22, 1968
226. St. Bonaventure University, St. Bonaventure, NY – April 22, 1968
227. St. Francis College, Loretto, PA – April 22, 1968
228. St. John Fisher College, Rochester, NY – April 22, 1968
229. St. John's University, Jamaica, NY – April 22, 1968
230. St. Joseph's University, Philadelphia, PA – April 22, 1968
231. St. Lawrence University, Canton, NY – April 22, 1968
232. St. Mary's University of Minnesota, Winona, MN – April 22, 1968
233. St. Mary's University, San Antonio, TX – April 22, 1968
234. St. Olaf College, Northfield, MN – April 22, 1968
235. St. Peter's College, Jersey City, NJ – April 22, 1968
236. Benedictine University, Lisle, IL – April 22, 1968
237. Salem College, Salem, WV – April 22, 1968
238. Sam Houston State University, Huntsville, TX – April 22, 1968
239. San Diego State University, San Diego, CA – April 22, 1968
240. California Stae University-Northridge, Northridge, CA – April 22, 1968
241. San Francisco State University, San Francisco, CA – April 22, 1968
242. San Francisco, University of, San Francisco, CA – April 22, 1968
243. San Jose State University, San Jose, CA – April 22, 1968

244. Santa Clara University of, Santa Clara, CA – April 22, 1968
245. Scranton, University of, Scranton, PA – April 22, 1968
246. Seattle Pacific University, Seattle, WA – April 22, 1968
247. Seattle University, Seattle, WA – April 22, 1968
248. Seton Hall University, South Orange, NJ – April 22, 1968
249. Slippery Rock University, Slippery Rock, PA – April 22, 1968
250. South, University of the, Sewanee, TN – April 22, 1968
251. South Dakota School of Mines & Technology, Rapid City, SD – April 22, 1968
252. South Dakota, University of, Vermillion, SD – April 22, 1968
253. South Florida, University of, Tampa, FL – April 22, 1968
254. Southeast Missouri State University, Cape Girardeau, MO – April 22, 1968
255. Southern Illinois University-Carbondale, Carbondale, IL – April 22, 1968
256. Southern Illinois University-Edwardsville, Edwardsville, IL – April 22, 1968
257. Southern Missionary College, Collegedale, TN – April 22, 1968
258. Southern Mississippi, University of, Hattiesburg, MS – April 22, 1968
259. Rhodes College, Memphis, TN – April 22, 1968
260. Southwestern Louisiana, University of, Lafayette, LA – April 22, 1968
261. Southwestern Oklahoma State University, Weatherford, OK – April 22, 1968
262. Spring Hill College, Mobile, AL – April 22, 1968
263. Stanford University, Stanford, CA – April 22, 1968
264. Albany, The University at, Albany, NY – April 22, 1968
265. SUNY at Binghamton, Binghamton, NY – April 22, 1968
266. SUNY at Stony Brook, Stony Brook, NY – April 22, 1968
267. SUNY at Plattsburgh, Plattsburgh, NY – April 22, 1968
268. Buffalo State College, Buffalo, NY – April 22, 1968
269. SUNY at Cortland, Cortland, NY – April 22, 1968
270. SUNY at Fredonia, Fredonia, NY – April 22, 1968
271. SUNY at Potsdam, Potsdam, NY – April 22, 1968
272. Stephen F. Austin State University, Nacogdoches, TX – April 22, 1968
273. Stetson University, DeLand, FL – April 22, 1968
274. Stevens Institute of Technology, Hoboken, NJ – April 22, 1968
275. Temple University, Philadelphia, PA – April 22, 1968
276. Tennessee Technological University, Cookeville, TN – April 22, 1968
277. Tennessee, University of, Knoxville, TN – April 22, 1968
278. Tennessee-Chattanooga, University of, Chattanooga, TN – April 22, 1968
279. Texas A&I University, Kingsville, TX – April 22, 1968
280. Texas A&M University, College Station, TX – April 22, 1968
281. Texas Christian University, Fort Worth, TX – April 22, 1968
282. Texas Southern University, Houston, TX – April 22, 1968
283. Texas Tech University, Lubbock, TX – April 22, 1968
284. Texas-Arlington, University of, Arlington, TX – April 22, 1968
285. Texas-Austin, University of, Austin, TX – April 22, 1968
286. Texas-El Paso, University of, El Paso, TX – April 22, 1968
287. Thiel College, Greenville, PA – April 22, 1968
288. Thomas More College, Fort Mitchell, NY – April 22, 1968
289. Trinity College, Hartford, CT – April 22, 1968
290. Trinity College, Washington, DC – April 22, 1968
291. Trinity University, San Antonio, TX – April 22, 1968
292. Tulane University, New Orleans, LA – April 22, 1968
293. Tulsa, University of, Tulsa, OK – April 22, 1968
294. Union College, Schenectady, NY – April 22, 1968
295. United States Air Force Academy, USAF Academy, CO – April 22, 1968
296. United States Naval Academy, Annapolis, MD – April 22, 1968
297. Upsala College, East Orange, NJ – April 22, 1968
298. Utica College of Syracuse University, Utica, NY – April 22, 1968
299. Valdosta State College, Valdosta, GA – April 22, 1968
300. Valparaiso University, Valparaiso, IN – April 22, 1968
301. Vanderbilt University, Nashville, TN – April 22, 1968
302. Villanova University, Villanova, PA – April 22, 1968
303. Virginia Military Institute, Lexington, VA – April 22, 1968
304. Virginia Tech, Blacksburg, VA – April 22, 1968
305. Norfolk State University, Norfolk, VA – April 22, 1968
306. Virginia State University, Petersburg, VA – April 22, 1968
307. Virginia, University of, Charlottesville, VA – April 22, 1968
308. Wake Forest University, Winston-Salem, NC – April 22, 1968
309. Walla Walla College, College Place, WA – April 22, 1968
310. Washburn University of Topeka, Topeka, KS – April 22, 1968
311. Washington State University, Pullman, WA – April 22, 1968
312. Washington University, St. Louis, MO – April 22, 1968
313. Washington & Jefferson College, Washington, PA – April 22, 1968
314. Washington, University of, Seattle, WA – April 22, 1968
315. West Chester University, West Chester, PA – April 22, 1968
316. West Virginia University, Morgantown, WV – April 22, 1968
317. Western Illinois University, Macomb, IL – April 22, 1968
318. Western Kentucky University, Bowling Green, KY – April 22, 1968
319. Westminster College, New Wilmington, PA – April 22, 1968
320. Wheaton College, Wheaton, IL – April 22, 1968
321. Wichita State University, Wichita, KS – April 22, 1968
322. Wilkes University, Wilkes-Barre, PA – April 22, 1968
323. William & Mary, College of, Williamsburg, VA – April 22, 1968
324. William Jewell College, Liberty, MO – April 22, 1968
325. Williams College, Williamstown, MA – April 22, 1968
326. Wisconsin-Platteville, University of, Platteville, WI – April 22, 1968
327. Wisconsin-Superior, University of, Superior, WI – April 22, 1968
328. Wisconsin-Whitewater, University of, Whitewater, WI – April 22, 1968
329. Wisconsin-Madison, University of, Madison, WI – April 22, 1968
330. Wittenberg University, Springfield, OH – April 22, 1968
331. Wooster, College of, Wooster, OH – April 22, 1968
332. Worcester Polytechnic Institute, Worcester, MA – April 22, 1968
333. Wright State University, Dayton, OH – April 22, 1968
334. Wyoming, University of, Laramie, WY – April 22, 1968
335. Xavier University, Cincinnati, OH – April 22, 1968
336. Yeshiva University, New York, NY – April 22, 1968
337. Moravian College, Bethlehem, PA – July 15, 1968
338. Louisiana at Monroe, University of, Monroe, LA (Northeast Louisiana University) – September 3, 1968
339. Rochester, University of, Rochester, NY – October 22, 1968
340. Georgia State University, Atlanta, GA – November 6, 1968
341. Northern Arizona University, Flagstaff, AZ – November 7, 1968
342. Utah State University, Logan, UT – November 18, 1968
343. Appalachian State University, Boone, NC – December 12, 1968
344. Akron, University of, Akron, OH – December 17, 1968
345. Pennsylvania, University of, Philadelphia, PA – December 17, 1968
346. Northwestern University, Evanston, IL – December 30, 1968
347. Principia College, Elsau, IL – January 7, 1969
348. Rochester Institute of Technology, Rochester, NY – January 7, 1969
349. State University of West Georgia (West Georgia College), Carrollton, GA – January 8, 1969
350. Southeastern Oklahoma State University, Durant, OK – January 21, 1969
351. Alabama-Huntsville, University of, Huntsville, AL – January 29, 1969
352. Austin Peay State University, Clarksville, TN – January 29, 1969
353. North Carolina-Wilmington, University of, Wilmington, NC – January 29, 1969
354. Wisconsin-Oshkosh, University of, Oshkosh, WI – January 29, 1969
355. Utah, University of, Salt Lake City, UT – February 17, 1969
356. Miami, University of Coral Gables – February 18, 1969
357. Eastern New Mexico University, Portales, NM – March 10, 1969
358. Florida Atlantic University, Boca Raton, FL – March 10, 1969
359. Frostburg State University, Frostburg MD – March 10, 1969
360. Pratt Institute, Brooklyn, NY – March 10, 1969
361. Wheeling Jesuit University, Wheeling, WV – March 10, 1969
362. American University, The, Washington, DC – March 21, 1969

363. Toledo, The University of, Toledo, OH – March 26, 1969
364. West Virginia Institute of Technology, Montgomery, WV – March 27, 1969
365. Elizabethtown College, Elizabethtown, PA – March 28, 1969
366. Jamestown College, Jamestown, ND – April 22, 1969
367. Northern Michigan University, Marquette, MI – April 22, 1969
368. Alfred University, Alfred, NY – May 19, 1969
369. Lawrence University, Appleton, WI – May 19, 1969
370. Northwestern State University, Natchitoches, LA – May 19, 1969
371. Weber State College, Ogden, UT – May 19, 1969
372. Drury College, Springfield, MO – May 23, 1969
373. Knox College, Galesburg, IL – May 23, 1969
374. California State Polytechnic University-Pomona, Pomona, CA – May 27, 1969
375. California State University-Sacramento, Sacramento, CA – May 29, 1969
376. Southern University and A&M College, Baton Rouge, LA – May 29, 1969
377. Central Missouri State University, Warrensburg, MO – June 3, 1969
378. Massachusetts-Boston, University of, Boston, MA – June 12, 1969
379. New Haven, University of, West Haven, CT – June 12, 1969
380. Birmingham-Southern College, Birmingham, AL – June 16, 1969
381. Wisconsin-Eau Claire, University of, Eau Claire, WI – June 16, 1969
382. Alabama-Birmingham, University of, Birmingham, AL – July 3, 1969
383. George Mason University, Fairfax, VA – July 11, 1969
384. California-Irvine, University of, Irvine, CA – August 5, 1969
385. Benedictine College, Atchison, KS – September 25, 1969
386. Hampden-Sydney College, Hampden-Sydney, VA – October 28, 1969
387. Bard College, Annandale-On-Hudson, NY – November 3, 1969
388. West Virginia State College, Institute, WV – November 3, 1969
389. East Stroudsburg University, East Stroudsburg, PA – November 13, 1969
390. Missouri Valley College, Marshall, MO – November 19, 1969
391. Abilene Christian University, Abilene, TX – December 3, 1969
392. Mississippi College, Clinton, MS – December 3, 1969
393. Central State University, Wilberforce, OH – December 15, 1969
394. Macalester College, St. Paul, MN – December 15, 1969
395. Southwest Missouri State University, Springfield, MO – December 29, 1969
396. Tennessee-Space Institute, University of, Tullahoma, TN – January 9, 1970
397. Bemidji State University, Bemidji, MN – January 20, 1970
398. Northern Iowa, University of, Cedar Falls, IA – January 23, 1970
399. St. John's University, Collegeville, MN – March 4, 1970
400. Cameron University, Lawton, OK – April 1, 1970
401. Montgomery Community College, Takoma Park, MD – April 1, 1970
402. Ottawa University, Ottawa, KS – April 1, 1970
403. Arkansas State University, State University, AR – April 8, 1970
404. Sauk Valley College, Dixon, IL – April 8, 1970
405. Siena College, Loudonville, NY – April 8, 1970
406. Park College, Parkville, MO – April 14, 1970
407. Nebraska, University of, Lincoln, NE – April 17, 1970
408. Arkansas Polytechnic College, Russellville, AR – May 11, 1970
409. California State University-Fresno, Fresno, CA – May 11, 1970
410. Central College, Pella, IA – May 12, 1970
411. Iowa, University of, Iowa City, IA – May 12, 1970
412. Grambling State University, Grambling, LA – May 21, 1970
413. Wisconsin-Stevens Point, University of, Stevens Point, WI – May 21, 1970
414. Missouri-Kansas City, University of, Kansas City, MO – May 26, 1970
415. Bradley University, Peoria, IL – June 23, 1970
416. Shippensburg University, Shippensburg, PA – June 23, 1970
417. Dillard University, New Orleans, LA – November 16, 1970
418. Austin College, Sherman, TX – January 12, 1971
419. Edinboro State College, Edinboro, PA – January 12, 1971
420. North Carolina-Charlotte, University of, Charlotte, NC – January 12, 1971
421. Dordt College, Sioux Center, IA – February 1, 1971
422. Hope College, Holland, MI – February 1, 1971
423. Youngstown State University, Youngstown, OH – February 1, 1971
424. Lawrence Institute of Technology, Southfield, MI – February 9, 1971
425. Northeastern Oklahoma State University, Tahlequah, OK – February 9, 1971
426. Puerto Rico-Mayaguez, University of, Mayaguez, PR – February 9, 1971
427. SUNY at Geneseo, Geneseo, NY – February 9, 1971
428. Heidelberg College, Tiffin, OH – March 24, 1971
429. York College of the CUNY, Jamaica, NY – March 24, 1971
430. Dallas Baptist College, Dallas, TX – April 30, 1971
431. West Florida, University of, Pensacola, FL – April 30, 1971
432. Southern Arkansas University, Magnolia, AR – June 15, 1971
433. Vermont, University of, Burlington, VT – June 15, 1971
434. Southern California, University of, Los Angeles, CA – July 13, 1971
435. Texas A&M University-Commerce, Commerce, TX – November 11, 1971
436. Missouri-St. Louis, University of, St. Louis, MO – November 30, 1971
437. Lynchburg College, Lynchburg, VA – January 3, 1972
438. Nebraska-Omaha, University of, Omaha, NE – January 3, 1972
439. Virginia Commonwealth University, Richmond, VA – January 3, 1972
440. Augsburg College, Minneapolis, MN – February 4, 1972
441. Calvin College, Grand Rapids, MI – February 4, 1972
442. Northwest Nazarene University (Northwest Nazarene College), Nampa, ID – February 4, 1972
443. SUNY at Oswego, Oswego, NY – March 1, 1972
444. Arkansas-Little Rock, University of, Little Rock, AR – April 21, 1972
445. Boston University, Boston, MA – April 21, 1972
446. Connecticut College, New London, CT – April 21, 1972
447. Swarthmore College, Swarthmore, PA – April 21, 1972
448. Henderson State University-Ouachita Baptist University, Arkadelphia, AR – May 8, 1972
449. Parsons College, Fairfield, IA – June 27, 1972
450. Central Florida, University of, Orlando, FL – July 7, 1972
451. Bethany College, Bethany, WV – July 12, 1972
452. Hiram College, Hiram, OH – July 12, 1972
453. Wagner College, Staten Island, NY – July 12, 1972
454. New Mexico Highlands University, Las Vegas, NV – December 15, 1972
455. Redlands, University of, Redlands, CA – January 29, 1973
456. Furman University, Greenville, SC – March 5, 1973
457. Mansfield University, Mansfield, PA – March 5, 1973
458. Saginaw Valley State University, University Center, MI – April 4, 1973
459. Southeastern Louisiana University, Hammond, LA – April 23, 1973
460. Towson University, Towson, MD – April 23, 1973
461. Trenton State College, Trenton, NJ – April 23, 1973
462. Montana State University, Bozeman, MT – May 1, 1973
463. Prairie View A&M University, Prairie View, TX – May 1, 1973
464. Southern Colorado, University of, Pueblo, CO – May 17, 1973
465. Southern Nazarene University, Bethany, OK – June 4, 1973
466. Coe College, Cedar Rapids, IA – June 4, 1973
467. Midwestern State University, Wichita Falls, TX – June 4, 1973
468. Guilford College, Greensboro, NC – June 25, 1973
469. United States Coast Guard Academy, New London, CT – June 25, 1973
470. Azusa Pacific College, Azusa, CA – August 23, 1973
471. Talladega College, Talladega, AL – November 11, 1973
472. Gordon College, Wenham, MA – December 14, 1973
473. Concordia College, Moorhead, MN – December 28, 1973
474. Minnesota State University (Moorhead State University), Moorhead, MN – December 28, 1973
475. Morehouse College, Atlanta, GA – January 24, 1974
476. Worcester State College, Worcester, MA – January 24, 1974
477. Wofford College, Spartanburg, SC – January 30, 1974
478. Massachusetts-Amherst, University of, Amherst, MA – February 19, 1974
479. SUNY at Brockport, Brockport, NY – February 19, 1974
480. Lock Haven University, Lock Haven, PA – February 28, 1974
481. Florida A&M University, Tallahassee, FL – March 11, 1974
482. Northern Kentucky University, Highland Heights, KY

- March 26, 1974
483. Concordia University, Montreal, Canada – March 26, 1974
  484. Rollins College, Winter Park, FL – April 18, 1974
  485. Wisconsin-River Falls, University of, River Falls, WI – April 18, 1974
  486. David Lipscomb College, Nashville, TN – May 10, 1974
  487. Sul Ross State University, Alpine, TX – May 22, 1974
  488. Lewis University, Lockport, IL – June 26, 1974
  489. Brandeis University, Waltham, MA – August 30, 1974
  490. SUNY at Oneonta, Oneonta, NY – November 20, 1974
  491. Kearney State College, Kearney, NE – December 18, 1974
  492. Texas State University (Southwest Texas State University), San Marcos, TX – December 24, 1974
  493. Juniata College, Huntingdon, PA – December 27, 1974
  494. Grand Valley State University (Grand Valley State College), Allendale, MI – January 22, 1975
  495. Western Washington University, Bellingham, WA – February 11, 1975
  496. Wesley College, Dover, DE – February 19, 1975
  497. Ottawa, University of, Ottawa, Canada – March 20, 1975
  498. Central Michigan University, Mount Pleasant, MI – March 27, 1975
  499. Puerto Rico-Rio Piedras, University of, Rio Piedras, PR – March 27, 1975
  500. Georgia Southern College, Statesboro, GA – April 23, 1975
  501. University of North Alabama, Florence, AL – April 23, 1975
  502. Westfield State College, Westfield, MA – May 23, 1975
  503. Charleston, College of, Charleston, SC – May 29, 1975
  504. Sonoma State University, Rohnert Park, CA – June 26, 1975
  505. Smith College, Northampton, MA – November 21, 1975
  506. Southwest Texas Junior College, Uvalde, TX – December 18, 1975
  507. Florida International University, Miami, FL – January 21, 1976
  508. Montclair State University, Upper Montclair, NJ – January 21, 1976
  509. Eastern Oregon University, La Grande, OR – February 12, 1976
  510. Jackson State University, Jackson, MS – March 25, 1976
  511. Maryland-Baltimore County, University of Baltimore, MD – May 7, 1976
  512. South Carolina, University of, Columbia, SC – May 26, 1976
  513. Wisconsin-Parkside, University of, Kenosha, WI – July 13, 1976
  514. Northern Colorado, University of, Greeley, CO – November 19, 1976
  515. North Carolina-Greensboro, University of, Greensboro, NC – January 20, 1977
  516. Queens College of the CUNY, Flushing, NY – February 11, 1987
  517. Mary Washington College, Fredericksburg, VA – March 8, 1977
  518. California State University-Hayward, Hayward, CA – April 4, 1977
  519. Millersville University, Millersville, PA – April 15, 1977
  520. Marquette University, Milwaukee, WI – May 2, 1977
  521. Western Carolina University, Cullowhee, NC – May 27, 1977
  522. Central Connecticut State University, New Britain, CT – July 13, 1977
  523. North Carolina - Asheville, University of, Asheville, NC – July 25, 1977
  524. Illinois at Chicago, University of, Chicago, IL – October 18, 1977
  525. Catholic University of America, The, Washington, DC – November 28, 1977
  526. District of Columbia, University of the, Washington, DC – November 28, 1977
  527. Southern Methodist University, Dallas, TX – December 12, 1977
  528. Geneva College, Beaver Falls, PA – March 17, 1978
  529. Illinois Wesleyan University, Bloomington, IL – May 9, 1978
  530. Mississippi, University of, University, MS – October 24, 1978
  531. Richard Stockton College of New Jersey, Pomona, NJ – December 27, 1978
  532. Clarion State College, Clarion, PA – December 29, 1978
  533. Nevada-Las Vegas, University of, Las Vegas, NV – December 29, 1978
  534. South Dakota State University, Brookings, SD – January 11, 1979
  535. SUNY at New Paltz, New Paltz, NY – January 11, 1979
  536. New Mexico Institute of Mining & Technology, Socorro, NM – January 18, 1979
  537. South Alabama, University of, Mobile, AL – January 24, 1979
  538. Elmhurst College, Elmhurst, IL – February 13, 1979
  539. St. Cloud State University, St. Cloud, NM – February 26, 1979
  540. Massachusetts College of Liberal Arts, North Adams, MA – March 28, 1979
  541. Georgian Court College, Lakewood, NJ – May 22, 1979
  542. Texas-Dallas, University of, Richardson, TX – October 17, 1979
  543. Suffolk University, Boston, MA – October 30, 1979
  544. Hendrix College, Conway, AR – December 26, 1979
  545. California State University-Dominguez Hills, Carson, CA – January 7, 1980
  546. Benedict College, Columbia, SC – January 9, 1980
  547. California-Berkeley, University of, Berkeley, CA – February 26, 1980
  548. Wayne State University, Detroit, MI – March 3, 1980
  549. Michigan, University of, Ann Arbor, MI – April 16, 1980
  550. California-Santa Cruz, University of, Santa Cruz, CA – June 23, 1980
  551. Mississippi Valley State University, Itta Bena, MS – October 27, 1980
  552. Columbia University, New York, NY – November 18, 1980
  553. Ursinus College, Collegeville, PA – January 5, 1981
  554. Massachusetts-Dartmouth, University of, N. Dartmouth, MA – February 9, 1981
  555. James Madison University, Harrisonburg, VA – April 2, 1981
  556. Luther College, Decorah, IA – April 2, 1981
  557. Presbyterian College, Clinton, SC – April 2, 1981
  558. Southern Oregon University, Ashland, OR – May 5, 1981
  559. Gustavus Adolphus College, St. Peter, MN – July 27, 1981
  560. Texas-San Antonio, University of, San Antonio, TX – August 17, 1981
  561. Ohio Wesleyan University, Delaware, OH – October 20, 1981
  562. Michigan-Dearborn, University of, Dearborn, MI – November 18, 1981
  563. California State University-Chico, Chico, CA – December 15, 1981
  564. Carleton College, Northfield, MN – December 15, 1981
  565. Alaska-Fairbanks, University of, Fairbanks, AK – December 15, 1981
  566. East Central Oklahoma State University, Ada, OK – December 29, 1981
  567. California Institute of Technology, Pasadena, CA – January 12, 1982
  568. Randolph Macon College, Ashland, VA – February 16, 1982
  569. Toronto, University of, Ontario, Canada – May 4, 1982
  570. California-San Diego, University of, La Jolla, CA – May 5, 1982
  571. Hawaii, University of, Honolulu, HI – May 7, 1982
  572. Pomona College, Claremont, CA – July 15, 1982
  573. Northeast Missouri State University, Kirksville, MO – August 4, 1982
  574. Howard Payne University, Brownwood, TX – November 9, 1982
  575. Belmont University (formerly College), Nashville, TN – June 1, 1983
  576. Wabash College, Crawfordsville, IN – November 8, 1983
  577. Alabama A&M University, Normal, AL – December 8, 1983
  578. Houston Baptist University, Houston, TX – January 1, 1984
  579. Dallas-Irving, University of, Irving, TX – February 22, 1984
  580. Western Michigan University, Kalamazoo, MI – March 8, 1984
  581. Mount Union College, Alliance, OH – March 30, 1984
  582. Central Piedmont Community College, Charlotte, NC – June 1, 1984
  583. Haverford College, Haverford, PA – June 22, 1984
  584. Northwest Missouri State University, Maryville, MO – December 12, 1984
  585. Middle Tennessee State University, Murfreesboro, TN – December 18, 1984
  586. Lincoln University, Lincoln, PA – February 5, 1985
  587. Tufts University, Medford, MA – February 6, 1985
  588. Hampton University, Hampton, VA – March 4, 1985
  589. Eastern Michigan University, Ypsilanti, MI – March 12, 1985
  590. Boise State University, Boise, ID – April 12, 1985
  591. Francis Marion University, Florence, SC – June 14, 1985
  592. Central Washington University, Ellensburg, WA – July 17, 1985
  593. Minnesota State University, Mankato (Mankato State University), Mankato, MN – October 24, 1985
  594. United States Military Academy, West Point, NY – November 7, 1985
  595. Millsaps College, Jackson, MS – December 10, 1985
  596. Colorado-Colorado Springs, University of, Colorado Springs, CO – January 10, 1986
  597. Portland State University, Portland, OR – February 3, 1996
  598. Lewis & Clark College, Portland, OR – February 4, 1986
  599. Wellesley College, Wellesley, MA – February 10,

- 1986
600. Maharishi International University, Fairfield, IA – February 18, 1996
601. Bryn Mawr College, Bryn Mawr, PA – March 12, 1986
602. New Hampshire, University of, Durham, NH – June 17, 1986
603. Princeton University, Princeton, NJ – September 29, 1986
604. Elizabeth City State University, Elizabeth City, NC – November 14, 1986
605. St. Norbert College, DePere, WI – November 17, 1986
606. Allegheny College, Meadville, PA – December 8, 1986
607. Hartford, University of, West Hartford, CT – December 8, 1986
608. Wesleyan University, Middletown, CT – December 17, 1986
609. West Texas A&M University, Canyon, TX – December 17, 1986
610. Eastern Washington University, Cheney, WA – February 10, 1987
611. Oregon, University of, Eugene, OR – February 10, 1987
612. Carroll College, Waukesha, WI – February 11, 1987
613. Green River Community College, Auburn, WA – April 4, 1987
614. Cornell University, Ithaca, NY – June 8, 1987
615. Tarleton State University, Stephenville, TX – June 8, 1987
616. De La Salle University, Manilla, Philippines – August 26, 1987
617. Susquehanna University, Selinsgrove, PA – November 9, 1987
618. St. Vincent College, Latrobe, PA – December 1, 1987
619. Metropolitan State College-Colorado, University of, Denver, CO – December 2, 1987
620. Cornell College, Mount Vernon, IA – December 4, 1987
621. Erskine College, Due West, SC – February 3, 1988
622. Samford University, Birmingham, AL – February 3, 1988
623. Florida Community College at Jacksonville, Jacksonville, FL – June 10, 1988
624. Brown University, Providence, RI – June 16, 1988
625. Gonzaga University, Spokane, WA – June 16, 1988
626. Pennsylvania State University at Erie, The Behrend College, Erie, PA – June 16, 1988
627. Transylvania University, Lexington, KY – January 30, 1989
628. Keene State College, Keene, NH – April 5, 1989
629. Mesa State College, Grand Junction, CO – August 23, 1989
630. Hamline University, St. Paul, MN – June 10, 1990
631. Chicago State University, Chicago, IL – July 10, 1990
632. California State University-San Bernardino, San Bernardino, CA – August 30, 1990
633. Mt. Holyoke College, South Hadley, MA – December 11, 1990
634. Northern Virginia Community College, Annandale, VA – December 11, 1990
635. Longwood College, Farmville, VA – December 19, 1990
636. Ithaca College, Ithaca, NY – December 21, 1990
637. Lenoir-Rhyne College, Hickory, NC – December 21, 1990
638. Owensboro Community & Technical College KY – February 21, 1991
639. Panola College, Carthage, TX – February 21, 1991
640. Indiana University-Purdue University at Indianapolis, Indianapolis, IN – March 25, 1991
641. Harrisburg Area Community College, Harrisburg, PA – March 25, 1991
642. Colorado Mountain College, Glenwood Springs, CO – May 9, 1991
643. Fort Lewis College, Durango, CO – May 9, 1991
644. Pikes Peak Community College, Colorado Springs, CO – May 9, 1991
645. Southwestern Michigan College, Dowagiac, MI – May 9, 1991
646. Athens State College, Athens, AL – May 16, 1991
647. Mt. San Antonio College, Walnut, CA – June 6, 1991
648. Michigan-Flint, University of, Flint, MI – November 14, 1991
649. Oglethorpe University, Atlanta, GA – November 14, 1991
650. Kutztown University, Kutztown, PA – December 1, 1991
651. East Tennessee State University, Johnson City, TN – December 17, 1991
652. Northeastern Illinois University, Chicago, IL – January 30, 1992
653. American University in Cairo, Cairo, Egypt – January 1, 1992
654. Mainland, College of the, Texas City, TX – January 1, 1992
655. Gainesville Community College, Gainesville, FL – February 19, 1992
656. Rowan University, Glassboro, NJ – April 13, 1992
657. Butler University, Indianapolis, IN – March 2, 1992
658. Xavier University of Louisiana, New Orleans, LA – May 5, 1992
659. St. Louis University, St. Louis, MO – August 4, 1992
660. Clark Atlanta University, Atlanta, GA – September 16, 1992
661. Hobart & William Smith Colleges, Geneva, NY – November 3, 1992
662. Centre College, Danville, KY – November 3, 1992
663. North Park University, Chicago, IL – November 1, 1992
664. Elon College, Graham, NC – April 26, 1993
665. Whittier College, Whittier, CA – May 24, 1993
666. Tyler Junior College, Tyler, TX – September 23, 1993
667. Berry College, Mt. Berry, GA – November 2, 1993
668. Northeast Texas Community College, Mt. Pleasant, TX – December 7, 1993
669. Bethel University (Bethel College), St. Paul, MN – January 4, 1994
670. Southwest Minnesota State University, Marshall, MN – February 10, 1994
671. California-Riverside, University of, Riverside, CA – March 8, 1994
672. Sciences in Philadelphia, University of the, Philadelphia, PA – October 19, 1994
673. McDaniel College, Westminster, MD – November 16, 1994
674. Temple College, Temple, TX – February 12, 1995
675. Oberlin College, Oberlin, OH – June 15, 1995
676. Southern Polytechnic State University, Marietta, GA – July 10, 1995
677. California Lutheran College, Thousand Oaks, CA – October 12, 1995
678. Ramapo College of New Jersey, Mahwah, NJ – October 12, 1995
679. Carthage College, Kenosha, WI – October 20, 1995
680. Hartnell Community College, Salinas, CA – December 5, 1995
681. Salisbury State University, Salisbury, MD – February 1996
682. Millikin University, Decatur, IL – February 27, 1996
683. Chicago, University of, Chicago, IL – March 6, 1996
684. Hillsdale College, Hillsdale, MI – March 21, 1996
685. St. Mary's College of California, Moraga, CA – July 1, 1996
686. Niagara County Community College, Sanborn, NY – November 12, 1996
687. Eckerd College, FL – February 13, 1997
688. Pacific University, OR – March 3, 1997
689. Ohio Northern University, Ada, OH – March 18, 1997
690. Southwestern College, Winfield, KS – April 4, 1997
691. Wisconsin-Milwaukee, University of, Milwaukee, WI – May 2, 1997
692. Indiana University-South Bend, South Bend, IN – May 16, 1997
693. Purdue University Calumet, Hammond, IN – May 20, 1997
694. South Carolina State University, Orangeburg, SC – June 12, 1997
695. Lawrence University, Appleton, WI – October 1, 1996
696. SUNY at Buffalo, Buffalo, NY – May 1, 1997
697. Southern Connecticut State University, New Haven, CT – July 1, 1997
698. St. Joseph College, West Hartford, CT – July 1, 1997
699. Western Connecticut State University, Danbury, CT – July 1, 1997
700. Yale University, New Haven, CT – July 1, 1997
701. Atlantic Union College, South Lancaster, MA – July 1, 1997
702. Eastern Nazarene College, Quincy, MA – July 1, 1997
703. Emmanuel College, Boston, MA – July 1, 1997
704. Fitchburg State College, Fitchburg, MA – July 1, 1997
705. Merrimack College, North Andover, MA – July 1, 1997
706. Simmons College, Boston, MA – July 1, 1997
707. Westfield State College, Westfield, MA – July 1, 1997
708. Wheaton College, Norton, MA – July 1, 1997
709. Worcester State College, Worcester, MA – July 1, 1997
710. Dartmouth College, Hanover, NH – July 1, 1997
711. Goddard College, Plainfield, VT – July 1, 1997
712. Marlboro College, Marlboro, VT – July 1, 1997
713. Norwich University, Northfield, VT – July 1, 1997
714. Bloomfield College, Bloomfield, NJ – July 1, 1997
715. Rider College, Lawrence, NJ – July 1, 1997
716. Albright College, Reading, PA – July 1, 1997
717. King's College, Wilkes-Barre, PA – July 1, 1997
718. Catawba College, Salisbury, NC – July 1, 1997
719. Pfeiffer College, Misenheimer, NC – July 1, 1997
720. Converse College, Spartanburg, SC – July 1, 1997
721. Illinois College, Jacksonville, IL – July 1, 1997
722. MacMurray College, Jacksonville, IL – July 1, 1997
723. Monmouth College, Monmouth, IL – July 1, 1997
724. Georgetown College, Georgetown, KY – July 1, 1997
725. Jefferson Community College, Louisville, KY – July 1, 1997
726. Kentucky Wesleyan College, Barbourville, KY – July 1, 1997

727. Union College, Barbourville, KY – July 1, 1997
728. Fisk University, Nashville, TN – July 1, 1997
729. Adams State College, Alamosa, CO – July 1, 1997
730. Colorado College, The, Colorado Springs, CO – July 1, 1997
731. Regis College, Denver, CO – July 1, 1997
732. Western State College of Colorado, Gunnison, CO – July 1, 1997
733. Spelman College, Atlanta, GA – February 26, 1998
734. Kettering University, Flint, MI – March 13, 1998
735. Louisiana State University-Shreveport, Shreveport, LA – March 19, 1998
736. Cumberlands, University of the, (Cumberland College), Williamsburg, KY – March 31, 1998
737. Wisconsin-La Crosse, University of, WI – May 1, 1998
738. Illinois, University of, Urbana-Champaign, IL – January 20, 1999
739. St. Mary's College of Maryland, St. Mary's City, MD – January 28, 1999
740. Kenyon College, Gambier, OH, – February 10, 1999
741. Randolph-Macon Woman's College, Lynchburg, VA – March 3, 1999
742. Reed College, Portland, OR – March 19, 1999
743. San Diego, University of, San Diego, CA – May 4, 1999
744. Indiana University-Purdue University, Fort Wayne, IN – January 13, 1999
745. Highland Community College, Freeport, IL – February 1, 1999
746. Tarrant County College, Hurst, TX - February 1, 1999
747. Skidmore College, Saratoga Springs, NY – May 3, 1999
748. Montana, University of, Missoula, MT - May 27, 1999
749. Notre Dame, University of, Notre Dame, IN – May 1, 1999
750. Embry-Riddle Aeronautical University, FL – November 5, 1999
751. Wells College, Aurora, NY – December 1, 1999
752. Ricks College, Rexburg, ID – December 1, 1999
753. Salem Community College, Carney's Point, NJ – December 3, 1999
754. Sweet Briar College, Sweet Briar, VA – June 1, 2000
755. St. Thomas, University of, St. Paul, MN – Oct. 17, 2000
756. Claremont Colleges, Joint Science Dept. of the, CA – Dec. 28, 2000
757. Wallace Community College, AL – March 1, 2001
758. Syracuse University, Syracuse, NY – September 21, 2001
759. College of Technology, VA – June 15, 2002
760. Mary Baldwin College, Staunton, VA – Sept. 13, 2002
761. Otterbein College, Westerville, OH – Dec. 30, 2002
762. Marietta College, Marietta, OH – Jan. 10, 2003
763. Southwestern University, Georgetown, TX – February 3, 2003
764. Kettering University, Flint, MI (B-Section) – March 28, 2003
765. Cypress College, Cypress, CA – Sept. 4, 2003
766. Utah Valley State College, Orem, UT – September 19, 2003
767. Wartburg College, Waverly, IA – Oct. 29, 2003
768. Milwaukee Area Technical College, Milwaukee, WI – November 4, 2003
769. Embry-Riddle Aeronautical University, Prescott, AZ – January 14, 2004
770. Radford University, Radford, VA – March 1, 2004
771. Tuskegee University, Tuskegee, AL – March 15, 2004
772. McNeese State University, Lake Charles, LA – September 15, 2004
773. Westminster College, Salt Lake City, UT – September 15, 2004
774. Texas Lutheran University, Seguin, TX – October 8, 2004
775. Georgia College & State University, Milledgeville, GA – Oct. 15, 2004
776. Union University, Jackson, TN – November 1, 2004
777. Nova Southeastern University, Ft. Lauderdale, FL – Nov. 15, 2004
778. Doane College, Crete, NE – Feb. 2, 2005
779. California University of Pennsylvania, California, PA – Feb. 23, 2005
780. Highline Community College, Des Moines, WA – May 17, 2005
781. Minnesota-Duluth, University of, Duluth, MN – Sept. 28, 2005
782. Delta College, University Center, MI – February 2, 2006
783. Earlham College, Richmond, IN – May 3, 2006
784. Coffeyville Community College, Coffeyville, KS – February 1, 2007
785. University of Calgary, Calgary, Alberta, Canada – April 1, 2007
786. Bellevue Community College, Bellevue, WA – May 1, 2007
787. Universidad de las Americas-Puebla, Puebla, Mexico – July 1, 2007
788. Washington & Lee University, Lexington, VA – October 10, 2007
789. Americas Puebla, Univ. de las, San Andres Cholula, Puebla, Mexico – January 17, 2008
790. Agnes Scott College, Decatur, GA – February 6, 2008
791. North Florida, University of, Jacksonville, FL – May 7, 2008
792. Vassar College, Poughkeepsie, NY – May 16, 2008
793. Calgary, University of, Calgary, AB – September 19, 2008
794. University of Texas at Tyler, Tyler TX – October 1, 2008
795. University of Southern Maine, Portland ME – October 21, 2008
796. Goucher College, Baltimore MD – October 22, 2008
797. East Los Angeles College, Monterey Park, CA – November 4, 2008
798. California State University at San Marcos, CA – February 5, 2009
799. Point Loma Nazarene University, San Diego, CA – March 7, 2009
800. Roberts Wesleyan College, Rochester, NY – April 20, 2009
801. Simpson College, Indianola, IA – May 18, 2009
802. The University of Texas at Brownsville and Texas Southmost College, Brownsville, TX – February 4, 2010
803. The City College of New York, New York, NY – June 2, 2010
804. California State University Stanislaus, Turlock, CA – June 2, 2010
805. High Point University, High Point, NC – June 10, 2010
806. Minnesota State Univ-Moorhead, Moorhead, MN – June 23, 2010
807. The Evergreen St. College, Olympia, WA – November 8, 2010
808. Linn-Benton Community College, Albany, OR – 2010
809. San Antonio College, San Antonio, TX – 2010
810. Southeast University, College Park, MD – February 28, 2011
811. Indiana Wesleyan University, Marion, IN – November 3, 2011
812. University of Puerto Rico at Humacao, Humacao, PR – 2012
813. The Sun Yat-Sen University, Guangzhao, China – November 2, 2012
814. Messiah College, Mechanicsburg, PA – April 15, 2013
815. Christopher Newport University Newport News, VA – April 11, 2013
816. Austin Community College, Austin, TX – November 2013
817. St. Michael's College, Colchester, VT – April 24, 2014
818. University of Alaska at Anchorage, Anchorage, AK – April 4, 2014
819. American River College, Sacramento, CA – April 4, 2014
820. Mercyhurst University, Erie PA – March 13, 2016
821. Vel Tech University, Avid, India – March 25, 2016
822. Univ. of Washington, Bothell Bothell, WA – June 20, 2016
823. Univ of Tennessee - Martin, Martin, TN – June 20, 2016
824. Portland Community College, Portland OR – August 8, 2016
825. Lee College, Baytown, TX – January 19, 2016
826. Chabot College, Hayward, CA – October 20, 2015
827. Alexandria Univ, Alexandria, Egypt – August 31, 2016
828. Florida Polytechnic University Lakeland, FL-- September 13, 2016
829. Victor Valley College, Victorville, CA – October 6, 2016
830. Missouri Southern State University, Joplin, MO – October 6, 2016
831. Peninsula College, Port Angeles, WA – January 24, 2017
832. Coastal Carolina University, Conway, SC – September 2, 2017
833. The University of Tampa, Tampa, FL-- November 6, 2017
834. Saint Anselm College, Manchester, NH – January 19, 2018
835. Del Mar College, Corpus Christi, TX – October 17, 2018
836. Santa Rosa Junior College, Santa Rosa, CA – March 12, 2018
837. CUYN/ LaGuardia Community College, Long Island City, NY – June 11, 2018
838. Universidad Autonoma de Ciudad Juarez, Ciudad Juarez, Mexico – August 21, 2018
839. University of La Verne, La Verne, CA – October 9, 2018
840. Institute of Enger & Management, West Bengal, India – October 20, 2018
841. CUNY of Staten Island, Staten Island, NY --2018
842. Howard Community College, Columbia, MD – August 6, 2019
843. Saint Catherine University, Saint Paul, MN – February 17, 2020
844. Troy University, Troy, AL – June 24, 2020
845. ShanghaiTech University, Shanghai, China – October 6, 2020

# Listing of Sigma Pi Sigma Chapters with Installation Dates

1. Davidson College, Davidson, NC -- December 11, 1921
2. Duke University, Durham, NC -- May 14, 1925
3. Pennsylvania State University, University Park, PA -- May 17, 1926
4. Centenary College of Louisiana, Shreveport, LA -- April 20, 1927
5. Furman University, Greenville, SC -- May 16, 1927
6. William & Mary, College of, Williamsburg, VA -- June 2, 1927
7. Tennessee-Chattanooga, University of, Chattanooga, TN -- May 17, 1929
8. West Virginia University, Morgantown, WV -- June 3, 1929
9. St. Lawrence University, Canton, NY -- June 7, 1929
10. Ohio Wesleyan University, Delaware, OH -- June 5, 1929
11. Kentucky, University of, Lexington, KY -- May 15, 1930
12. Oklahoma, University of, Norman, OK -- May 17, 1930
13. Park College, Parkville, MO -- May 19, 1930
14. William Jewell College, Liberty, MO -- May 20, 1930
15. Morningside College, Sioux City, IA -- May 21, 1930
16. Colorado, University of, Boulder, CO -- May 22, 1930
17. Washington, University of, Seattle, WA -- May 26, 1930
18. Lake Forest College, Lake Forest, IL -- May 31, 1930
19. Wooster, College of, Wooster, OH -- June 2, 1930
20. Wheaton College, Wheaton, IL -- June 3, 1931
21. Richmond, University of, Richmond, VA -- March 16, 1932
22. Purdue University, West Lafayette, IN -- April 12, 1932
23. Miami University, Oxford, OH -- June 4, 1932
24. Illinois-Chicago, University of, Chicago, IL -- June 6, 1932
25. Philippines, University of the, Quezon City, PI -- July 6, 1932
26. Syracuse University, Syracuse, NY -- May 29, 1933
27. Oregon State University, Corvallis, OR -- May 19, 1934
28. Denver, University of, Denver, CO -- May 28, 1934
29. Michigan State University, East Lansing, MI -- March 2, 1935
30. Brigham Young University, Provo, UT -- May 2, 1936
31. George Washington University, Washington, DC -- May 22, 1936
32. Ohio State University, Columbus, OH -- May 28, 1936
33. Stetson University, DeLand, FL -- May 10, 1937
34. Berea College, Berea, KY -- May 17, 1937
35. New York University, New York, NY -- June 15, 1937
36. Pittsburgh, University of, Pittsburgh, PA -- April 8, 1938
37. Franklin & Marshall College, Lancaster, PA -- May 28, 1938
38. Fort Hays State University, Hays, KS -- April 4, 1939
39. Wayne State University, Detroit, MI -- May 22, 1939
40. San Diego State University, San Diego, CA -- May 23, 1940
41. Muskingum College, New Concord, OH -- May 31, 1940
42. Citadel, The, Charleston, SC -- January 10, 1941
43. Georgia, University of, Athens, GA -- May 19, 1941
44. Texas-Austin, University of, Austin, TX -- May 10, 1946
45. Nebraska Wesleyan University, Lincoln, NE -- May 8, 1947
46. Marquette University, Milwaukee, WI -- May 9, 1947
47. Tufts University, Medford, MA -- May 20, 1947
48. Redlands, University of, Redlands, CA -- May 30, 1947
49. South Dakota State University, Brookings, SD -- June 17, 1947
50. South Dakota, The University of, Vermillion, SD -- June 17, 1947
51. Bucknell University, Lewisburg, PA -- February 14, 1948
52. Maryland-College Park, University of, College Park, MD -- March 17, 1948
53. Manchester College, North Manchester, IN -- April 28, 1948
54. Colby College, Waterville, ME -- May 5, 1948
55. Oregon, University of, Eugene, OR -- May 10, 1948
56. Occidental College, Los Angeles, CA -- May 12, 1948
57. Arkansas, University of, Fayetteville, AR -- May 13, 1948
58. Oklahoma State University, Stillwater, OK -- May 14, 1948
59. Emory University, Atlanta, GA -- May 17, 1948
60. Utah, University of, Salt Lake City, UT -- June 8, 1948
61. Howard University, Washington, DC -- March 7, 1949
62. Clemson University, Clemson, SC -- March 25, 1949
63. Georgia Institute of Technology, Atlanta, GA -- March 28, 1949
64. Gettysburg College, Gettysburg, PA -- May 2, 1949
65. Illinois Institute of Technology, Chicago, IL -- May 7, 1949
66. Southern Illinois University, Carbondale, IL -- May 9, 1949
67. Evansville, University of, Evansville, IN -- May 10, 1949
68. Alabama, University of, University, AL -- May 18, 1949
69. Maine, University of, Orono, ME -- May 25, 1949
70. Trinity College, Hartford, CT -- May 26, 1949
71. Delaware, University of, Newark, DE -- June 1, 1949
72. Virginia Tech, Blacksburg, VA -- June 4, 1949
73. Wyoming, University of, Laramie, WY -- June 10, 1949
74. Missouri-Rolla, University of, Rolla, MO -- January 11, 1950
75. Auburn University, Auburn, AL -- April 5, 1950
76. Tulane University, New Orleans, LA -- April 12, 1950
77. St. Olaf College, Northfield, MN -- May 9, 1950
78. Kansas, University of, Lawrence, KS -- May 15, 1950
79. Arizona, University of, Tucson, AZ -- May 17, 1950
80. Louisiana State University, Baton Rouge, LA -- May 19, 1950
81. Connecticut, University of, Storrs, CT -- May 25, 1950
82. New Hampshire, University of, Durham, NH -- May 26, 1950
83. Hofstra University, Hempstead, NY -- March 17, 1951
84. Virginia State University, Petersburg, VA -- April 19, 1951
85. St. Joseph's University, Philadelphia, PA -- April 30, 1951
86. Manhattan College, Bronx, NY -- April 30, 1951
87. South Dakota School of Mines & Technology, Rapid City, SC -- June 1, 1951
88. Louisville, University of, Louisville, KY -- March 28, 1952
89. North Carolina State University, Raleigh, NC -- March 26, 1953
90. Boston College, Chestnut Hill, MA -- May 11, 1953
91. California-Los Angeles, University of, Los Angeles, CA -- May 29, 1953
92. Tennessee, University of, Knoxville, TN -- April 1, 1954
93. Florida State University, Tallahassee, FL -- May 14, 1954
94. Upsala College, East Orange, NJ -- May 28, 1954
95. Temple University, Philadelphia, PA -- June 10, 1954
96. Loyola University of New Orleans, New Orleans, LA -- December 11, 1954
97. Texas Tech University, Lubbock, TX -- December 13, 1954
98. Hawaii, University of, Honolulu, HI -- December 18, 1954
99. Wabash College, Crawfordsville, IN -- May 21, 1955
100. South Carolina, University of, Columbia, SC -- April 25, 1956
101. Houston-University Park, University of, Houston, TX -- May 23, 1956
102. Florida, University of, Gainesville, FL -- February 22, 1957
103. Wichita State University, Wichita, KS -- May 5, 1958
104. Nevada-Reno, University of, Reno, NV -- May 7, 1958
105. Ohio University, Athens, OH -- May 20, 1958
106. Utica College of Syracuse University, Utica, NY -- May 24, 1958
107. South, The University of the, Sewanee, TN -- May 26, 1958
108. Polytechnic Institute of New York, Brooklyn, NY -- April 3, 1959
109. Western Illinois University, Macomb, IL -- April 7, 1959

110. Texas A&M University, College Station, TX -- April 13, 1959
111. Baylor University, Waco, TX -- April 15, 1959
112. Linfield College, McMinnville, OR -- April 17, 1959
113. Utah State University, Logan, UT -- April 20, 1959
114. Westminster College, New Wilmington, PA -- April 28, 1959
115. New Mexico State University, Las Cruces, NM -- April 12, 1960
116. Idaho, University of, Moscow, ID -- April 20, 1960
117. Washburn University of Topeka, Topeka, KS -- May 6, 1960
118. Southwestern Louisiana, University of, Lafayette, LA -- May 9, 1960
119. St. Bonaventure University, St. Bonaventure, NY -- May 16, 1960
120. Albany, University at, Albany, NY -- May 19, 1960
121. Western Kentucky University, Bowling Green, KY -- May 25, 1960
122. New York University, Bronx, NY -- May 27, 1960
123. Clark University, Worcester, MA -- April 27, 1962
124. Adelphi University, Garden City, NY -- April 30, 1962
125. McMurry University, Abilene, TX -- May 3, 1962
126. Texas-El Paso, University of, El Paso, TX -- May 7, 1962
127. Colorado State University, Fort Collins, CO -- May 9, 1962
128. Providence College, Providence, RI -- May 15, 1962
129. Indiana University, Bloomington, IN -- December 16, 1962
130. Rensselaer Polytechnic Institute, Troy, NY -- March 9, 1963
131. California State University-Los Angeles, Los Angeles, CA -- April 27, 1963
132. Texas Christian University, Fort Worth, TX -- April 29, 1963
133. Benedictine University, Lisle, IL -- May 13, 1963
134. Xavier University, Cincinnati, OH -- May 18, 1963
135. Tulsa, University of, Tulsa, OK -- May 18, 1963
136. Oklahoma City University, Oklahoma City, OK -- May 20, 1963
137. Murray State University, Murray, KY -- May 23, 1963
138. Rhodes College, Memphis, TN -- May 27, 1963
139. Detroit, University of, Detroit, MI -- June 6, 1963
140. Albion College, Albion, MI -- April 10, 1964
141. St. Mary's University of Minnesota, Winona, MN -- May 4, 1964
142. Nebraska-Lincoln, University of, Lincoln, NE -- May 28, 1964
143. Rutgers University, Newark College of Arts & Sciences, Newark, NJ -- December 18, 1964
144. Sam Houston State University, Huntsville, TX -- April 20, 1965
145. North Texas, University of, Denton, TX -- April 21, 1965
146. Lamar University, Beaumont, TX -- April 22, 1965
147. Drexel University, Philadelphia, PA -- June 4, 1965
148. Duquesne University, Pittsburgh, PA -- June 10, 1965
149. Stephen F. Austin State University, Nacogdoches, TX -- February 21, 1966
150. Trinity University, San Antonio, TX -- February 23, 1966
151. Texas-Arlington, University of, Arlington, TX -- February 28, 1966
152. South Florida, University of, Tampa, FL -- March 3, 1966
153. Virginia, University of, Charlottesville, VA -- March 8, 1966
154. Trinity College, Washington, DC -- March 19, 1966
155. California-Santa Barbara, University of, Santa Barbara, CA -- April 16, 1966
156. Virginia Military Institute, Lexington, VA -- April 19, 1966
157. Roanoke College, Salem, VA -- April 21, 1966
158. Rose-Hulman Institute of Technology, Terre Haute, IN -- May 10, 1966
159. DePauw University, Greencastle, IN -- May 11, 1966
160. United States Naval Academy, Annapolis, MD -- June 2, 1966
161. Emporia State University, Emporia, KS -- November 14, 1966
162. California State University-Northridge, Northridge, CA -- December 2, 1966
163. Monmouth College, West Long Branch, NJ -- January 8, 1967
164. Louisiana Tech University, Ruston, LA -- February 15, 1967
165. Morehead State University, Morehead, KY -- March 20, 1967
166. Loma Linda University, Riverside, CA -- April 4, 1967
167. Pan American University, Edinburg, TX -- May 10, 1967
168. Memphis, University of, Memphis, TN -- May 12, 1967
169. Salem College, Salem, WV -- March 8, 1968
170. Dayton, University of, Dayton, OH -- March 11, 1968
171. Denison University, Granville, OH -- April 29, 1968
172. Wisconsin-Superior, University of, Superior, WI -- May 8, 1968
173. Pacific Union College, Angwin, CA -- May 15, 1968
174. Carson-Newman College, Jefferson City, TN -- May 20, 1968
175. Widener University, Chester, PA -- May 22, 1968
176. Johns Hopkins University, Baltimore, MD -- May 24, 1968
177. Dickinson College, Carlisle, PA -- June 2, 1968
178. Moravian College, Bethlehem, PA -- October 16, 1968
179. Northern Arizona University, Flagstaff, AZ -- November 7, 1968
180. Ball State University, Muncie, IN -- November 8, 1968
181. Cooper Union, The, New York, NY -- November 21, 1968
182. Massachusetts-Lowell, University of, Lowell, MA -- November 23, 1968
183. Louisiana at Monroe, University of, Monroe, LA (formerly Northeast Louisiana University) -- December 3, 1968
184. Yeshiva University, New York, NY -- January 2, 1969
185. Ripon College, Ripon, WI -- January 28, 1969
186. Scranton, University of, Scranton, PA -- February 15, 1969
187. Florida Southern College, Lakeland, FL -- March 6, 1969
188. Appalachian State University, Boone, NC -- March 19, 1969
189. Rochester Institute of Technology, Rochester, NY -- March 28, 1969
190. Hanover College, Hanover, IN -- April 1, 1969
191. Clarkson University, Potsdam, NY -- April 8, 1969
192. Southeast Missouri State University, Cape Girardeau, MO -- April 10, 1969
193. Florida Institute of Technology, Melbourne, FL -- April 12, 1969
194. Seton Hall University, South Orange, NJ -- April 15, 1969
195. Rutgers University, Camden College of Arts & Sciences, Camden, NJ -- April 15, 1969
196. North Carolina-Wilmington, University of, Wilmington, NC -- April 18, 1969
197. Wisconsin-Oshkosh, University of, Oshkosh, WI -- April 23, 1969
198. Wisconsin-Whitewater, University of, Whitewater, WI -- April 24, 1969
199. Pittsburg State University, Pittsburg, KS -- May 6, 1969
200. Toledo, The University of, Toledo, OH -- May 7, 1969
201. Santa Clara University (Santa Clara, University of), Santa Clara, CA -- May 7, 1969
202. Akron, University of, Akron, OH -- May 8, 1969
203. Rhode Island, University of, Kingston, RI -- May 9, 1969
204. SUNY at Stony Brook, NY -- May 12, 1969
205. Augustana College, Rock Island, IL -- May 12, 1969
206. California State University-Long Beach, Long Beach, CA -- May 12, 1969
207. New Orleans, University of, New Orleans, LA -- May 13, 1969
208. Austin Peay State University, Clarksville, TN -- May 14, 1969
209. Cleveland State University, Cleveland, OH -- May 15, 1969
210. Southwestern Oklahoma State University, Weatherford, OK -- May 16, 1969
211. Bowling Green State University, Bowling Green, OH -- May 17, 1969
212. Miami, University of, Coral Gables, FL -- May 20, 1969
213. Wisconsin-Platteville, University of, Platteville, WI -- May 22, 1969
214. St. Peter's College, Jersey City, NJ -- May 25, 1969
215. California Polytechnic State University-San Luis Obispo, San Luis Obispo, CA -- May 26, 1969
216. Georgia State University, Atlanta, GA -- May 27, 1969
217. Idaho State University, Pocatello, ID -- May 27, 1969
218. Cincinnati, University of, Cincinnati, OH -- May 28, 1969
219. Wright State University, Dayton, OH -- May 29, 1969
220. California State Polytechnic University-Pomona, Pomona, CA -- May 29, 1969
221. Morgan State University, Baltimore, MD -- October 11, 1969
222. Birmingham-Southern College, Birmingham, AL -- November 3, 1969
223. Alabama-Huntsville, University of, Huntsville, AL -- November 4, 1969
224. Iona College, New Rochelle, NY -- January 1, 1970
225. Holy Cross, College of the, Worcester, MA -- February 19, 1970
226. Worcester Polytechnic Institute, Worcester, MA -- February 20, 1970
227. Mississippi State University, Mississippi, MS -- March 12, 1970
228. Bloomsburg University, Bloomsburg, PA -- March 17, 1970



229. Pratt Institute, Brooklyn, NY -- March 17, 1970
230. California State University-Sacramento, Sacramento, CA -- April 8, 1970
231. George Mason University, Fairfax, VA -- April 10, 1970
232. Rice University, Houston, TX -- April 15, 1970
233. Central Missouri State University, Warrensburg, MO -- April 16, 1970
234. Northwestern University, Evanston, IL -- April 17, 1970
235. Thomas More College, Fort Mitchell, KY -- April 30, 1970
236. Tennessee-Space Institute, University of, Tullahoma, TN -- May 5, 1970
237. Indiana State University, Terre haute, IN -- May 5, 1970
238. Fordham University, Bronx, NY -- May 5, 1970
239. Central Oklahoma, University of, Edmond, OK -- May 6, 1970
240. Grove City College, Grove City, PA -- May 9, 1970
241. Elizabethtown College, Elizabethtown, PA -- May 9, 1970
242. SUNY at Fredonia, Fredonia, NY -- May 12, 1970
243. Boston State College, Boston, MA -- May 13, 1970
244. Eastern Illinois University, Charleston, IL -- May 19, 1970
245. California-Irvine, University of, Irvine, CA -- May 21, 1970
246. Mississippi College, Clinton, MS -- May 28, 1970
247. East Stroudsburg University, East Stroudsburg, PA -- October 20, 1970
248. Jacksonville University, Jacksonville, FL -- November 10, 1970
249. Hunter College of the CUNY, New York, NY -- December 2, 1970
250. Missouri-Kansas City, University of, Kansas City, MO -- January 8, 1971
251. New York Institute of Technology, Old Westbury, NY -- January 11, 1971
252. Seattle University, Seattle, WA -- February 24, 1971
253. Bradley University, Peoria, IL -- March 13, 1971
254. Arkansas State University, State University, AR -- March 14, 1971
255. Benedictine College, Atchison, KS -- March 25, 1971
256. Buffalo State College, Buffalo, NY -- March 26, 1971
257. Northwestern State University of Louisiana, Natchitoches, LA -- April 23, 1971
258. Old Dominion University, Norfolk, VA -- April 30, 1971
259. West Virginia Institute of Technology, Montgomery, WV -- April 30, 1971
260. Ottawa University, Ottawa, KS -- May 4, 1971
261. Wake Forest University, Winston-Salem, NC -- May 5, 1971
262. Loyola College, Baltimore, MD -- May 7, 1971
263. Grambling State University, Grambling, LA -- May 7, 1971
264. American University, The, Washington, DC -- May 14, 1971
265. Southern Mississippi, University of, Hattiesburg, MS -- May 15, 1971
266. Eastern new Mexico University, Portales, NM -- May 22, 1971
267. Jamestown College, Jamestown, ND -- May 24, 1971
268. Bemidji State University, Bemidji, MN -- May 31, 1971
269. Bridgeport, University of, Bridgeport, CT -- June 3, 1971
270. Edinboro University, Edinboro, PA -- October 16, 1971
271. Thiel College, Greenville, PA -- October 19, 1971
272. Muhlenberg College, Allentown, PA -- February 25, 1972
273. Dordt College, Sioux Center, IA -- March 8, 1972
274. Southwest Missouri State University, Springfield, MO -- April 6, 1972
275. Texas A&M University-Commerce, Commerce, TX -- April 21, 1972
276. Gannon University, Erie, PA -- April 22, 1972
277. SUNY at Geneseo, Geneseo, NY -- April 26, 1972
278. Austin College, Sherman, TX -- April 28, 1972
279. Indiana University of Pennsylvania, Indiana, PA -- May 4, 1972
280. Lynchburg College, Lynchburg, VA -- May 4, 1972
281. Southern Arkansas University, Magnolia, AR -- May 4, 1972
282. East Carolina University, Greenville, NC -- May 10, 1972
283. Kent State University, Kent, OH -- May 10, 1972
284. Southern University and A&M College, Baton Rouge, LA -- May 10, 1972
285. Youngstown State University, Youngstown, OH -- May 10, 1972
286. Lawrence Technological University, Southfield, MI -- May 11, 1972
287. Nebraska-Omaha, University of, Omaha, NE -- May 17, 1972
288. Puget Sound, University of, Tacoma, WA -- May 19, 1972
289. Southern California, University of, Los Angeles, CA -- May 19, 1972
290. Kansas Wesleyan University, Salina, KS -- September 14, 1972
291. De Paul University, Chicago, IL -- November 10, 1972
292. Wagner College, Staten Island, NY -- January 11, 1973
293. Shippensburg University, Shippensburg, PA -- February 10, 1973
294. Abilene Christian University, Abilene, TX -- March 1, 1973
295. Texas A&M University-Kingsville, Kingsville, TX -- March 22, 1973
296. Frostburg State University, Frostburg, MD -- March 31, 1973
297. Henderson State University-Oachita Baptist University, Arkadelphia, AR -- April 12, 1973
298. Lycoming College, Williamsport, PA -- April 16, 1973
299. North Dakota State University, Fargo, ND -- April 30, 1973
300. SUNY at Oswego, Oswego, NY -- May 10, 1973
301. Northern Illinois University Dekalb, IL -- May 11, 1973
302. West Florida, University of, Pensacola, FL -- May 25, 1973
303. St. John's University, Jamaica, NY -- December 5, 1973
304. Saginaw Valley State University, University Center, MI -- December 14, 1973
305. Concordia College, Moorhead, MN -- December 28, 1973
306. Moorhead State University, Moorhead, MN -- December 28, 1973
307. Trenton State College, Trenton, NJ -- March 28, 1974
308. Prairie View A&M University, Prairie View, TX -- April 3, 1974
309. Southern Colorado, University of, Pueblo, CO -- April 5, 1974
310. North Carolina-Charlotte, University of, Charlotte, NC -- April 18, 1974
311. Cameron University, Lawton, OK -- May 10, 1974
312. SUNY at Binghamton, Binghamton, NY -- May 20, 1974
313. Siena College, Loudonville, NY -- October 23, 1974
314. Montana State University, Bozeman, MT -- November 8, 1974
315. New Mexico Highlands University, Las Vegas, NM -- November 10, 1974
316. Andrews University, Berrien Springs, MI -- December 4, 1974
317. Juniata College, Huntingdon, PA -- March 19, 1975
318. Lewis University, Lockport, IL -- March 22, 1975
319. Midwestern State University, Wichita Falls, TX -- April 4, 1975
320. Union College, Schenectady, NY -- April 8, 1975
321. John Carroll University, University Heights, OH -- April 17, 1975
322. Nebraska-Kearney, University of, Kearney, NE -- April 22, 1975
323. Slippery Rock University, Slippery Rock, PA -- April 22, 1975
324. Rollins College, Winter park, FL -- April 28, 1975
325. Towson University, Towson, MD -- May 1, 1975
326. Heidelberg College, Tiffin, OH -- May 6, 1975
327. Wisconsin-River Falls, University of, River Falls, WI -- May 9, 1975
328. SUNY at Oneonta, Oneonta, NY -- May 16, 1975
329. Tennessee Technological University, Cookeville, TN -- February 26, 1976
330. Western Washington University, Bellingham, WA -- March 12, 1976
331. Iowa State University, Ames, IA -- March 13, 1976
332. North Alabama, University of, Florence, AL -- March 23, 1976
333. Texas State University (Southwest Texas State University), San Marcos, TX -- March 26, 1976
334. Morehouse College, Atlanta, GA -- March 31, 1976
335. Augsburg College, Minneapolis, MN -- April 12, 1976
336. Central Michigan University, Mount Pleasant, MI -- April 19, 1976
337. Michigan Technological University, Houghton, MI -- April 20, 1976
338. Kansas State University, Manhattan, KS -- May 5, 1976
339. Eastern Oregon University, La Grande, OR -- May 13, 1976
340. Massachusetts-Boston, University of, Boston, MA -- May 15, 1976
341. North Georgia College, Dahlonega, GA -- May 21, 1976
342. Florida International University, Miami, FL -- May 27, 1976
343. Villanova University, Villanova, PA -- February 11, 1977
344. Valparaiso University, Valparaiso, IN -- April 8, 1977
345. Angelo State University, San Angelo, TX -- April 15, 1977
346. Guilford College, Greensboro, NC -- April 21, 1977

347. North Carolina-Greensboro, University of, Greensboro, NC -- April 21, 1977
348. Jackson State University, Jackson, MS -- January 24, 1978
349. Colorado School of Mines, Golden, CO -- April 10, 1978
350. California State University-Hayward, Hayward, CA -- April 12, 1978
351. Northeastern Oklahoma State University, Tahlequah, OK -- April 28, 1978
352. Southern Methodist University, Dallas, TX -- May 18, 1978
353. SUNY at Cortland, Cortland, NY -- October 5, 1978
354. Virginia Commonwealth University, Richmond, VA -- October 13, 1978
355. Valdosta State College, Valdosta, GA -- November 15, 1978
356. Wisconsin-Eau Claire, University of, Eau Claire, WI -- February 23, 1979
357. Mississippi, University of, University, MS -- March 29, 1979
358. Wilkes University, Wilkes-Barre, PA -- April 27, 1979
359. South Alabama, University of, Mobile, AL -- May 4, 1979
360. Loyola Marymount University, Los Angeles, CA -- May 11, 1979
361. Minnesota, University of, Minneapolis, MN -- May 18, 1979
362. Elmhurst College, Elmhurst, IL -- December 1, 1979
363. Loyola University of Chicago, Chicago, IL -- April 23, 1980
364. Vanderbilt University, Nashville, TN -- April 30, 1980
365. SUNY at Potsdam, Potsdam, NY -- May 3, 1980
366. SUNY at Plattsburgh, Plattsburgh, NY -- May 3, 1980
367. Olivet Nazarene University, Kankakee, IL -- May 21, 1980
368. Maryland-Baltimore County, University of, Baltimore, MD -- June 4, 1980
369. Alma College, Alma, MI -- April 4, 1981
370. Ursinus College, Collegeville, PA -- April 11, 1981
371. Boston University, Boston, MA -- April 16, 1981
372. Arkansas-Little Rock, University of, Little Rock, AR -- April 20, 1981
373. Millersville University, Millersville, PA -- April 28, 1981
374. California-Santa Cruz, University of, Santa Cruz, CA -- April 30, 1981
375. Georgia Southern College, Statesboro, GA -- May 22, 1981
376. California-Davis, University of, Davis, CA -- May 28, 1981
377. Southern Oregon University, Ashland, OR -- November 22, 1981
378. San Francisco, University of, San Francisco, CA -- December 4, 1981
379. California State University-Fresno, Fresno, CA -- February 3, 1982
380. Presbyterian College, Clinton, SC -- March 25, 1982
381. Hope College, Holland, MI -- April 16, 1982
382. Richard Stockton College of New Jersey, Pomona, NJ -- April 28, 1982
383. Massachusetts Institute of Technology, Cambridge, MA -- May 2, 1982
384. Creighton University, Omaha, NE -- December 5, 1982
385. Benedict College, Columbia, SC -- March 16, 1983
386. North Carolina-Chapel Hill, University of, Chapel Hill, NC -- April 6, 1983
387. Iowa, University of, Iowa City, IA -- April 8, 1983
388. James Madison University, Harrisonburg, VA -- April 22, 1983
389. Central Arkansas, University of, Conway, AR -- April 26, 1983
390. Columbia University, New York, NY -- May 2, 1983
391. Massachusetts-Dartmouth, University of, North Dartmouth, MA -- May 2, 1983
392. California State University-Chico, Chico, CA -- May 10, 1983
393. Arizona State University, Tempe, AZ -- October 28, 1983
394. Northern Iowa, University of, Cedar Falls, IA -- November 4, 1983
395. Luther College, Decorah, IA -- April 3, 1984
396. Principia College, Elsau, IL -- April 12, 1984
397. Texas Southern University, Houston, TX -- April 18, 1984
398. Eastern Kentucky University, Richmond, KY -- May 1, 1984
399. California-Berkeley, University of, Berkeley, CA -- November 9, 1984
400. Dallas-Irving, University of, Irving, TX -- November 27, 1984
401. Randolph-Macon College, Ashland, VA -- May 10, 1985
402. State University of West Georgia (West Georgia College), Carrollton, GA -- May 24, 1985
403. Hampton University, Hampton, VA -- November 13, 1985
404. Eastern Michigan University, Ypsilanti, MI -- November 16, 1985
405. North Carolina-Asheville, University of, Asheville, NC -- November 22, 1985
406. Francis Marion University (Francis Marion College), Florence, SC -- April 10, 1986
407. Mt. Union College, Alliance, OH -- April 16, 1986
408. Mary Washington College, Fredericksburg, VA -- May 2, 1986
409. United States Military Academy, West Point, NY -- May 2, 1986
410. Michigan, University of, Ann Arbor, MI -- May 3, 1986
411. Colorado-Colorado Springs, University of, Colorado Springs, CO -- May 13, 1986
412. Northeastern University, Boston, MA -- June 2, 1986
413. Lewis & Clark College, Portland, OR -- June 4, 1986
414. West Chester University, West Chester, PA -- November 3, 1986
415. Lincoln University, Lincoln University, PA -- April 4, 1987
416. Central Washington University, Ellensburg, WA -- May 2, 1987
417. Northeast Missouri State University, Kirksville, MO -- October 23, 1987
418. Middle Tennessee State University, Murfreesboro, TN -- October 29, 1987
419. San Jose State University, San Jose, CA -- December 1, 1987
420. College of Charleston, Charleston, SC -- December 2, 1987
421. Millsaps College, Jackson, MS -- February 4, 1988
422. Drew University, Madison, NJ -- April 13, 1988
423. Susquehanna University, Selingsgrove, PA -- April 15, 1988
424. Wellesley College, Wellesley, MA -- April 25, 1988
425. Carroll College, Waukesha, WI -- May 3, 1988
426. Rutgers University-New Brunswick, Piscataway, NJ -- May 3, 1988
427. Gonzaga University, Spokane, WA -- June 16, 1988
428. Transylvania University, Lexington, KY -- January 30, 1989
429. Texas-Dallas, University of, Dallas, TX -- April 1, 1989
430. Keene State College, Keene, NH -- April 5, 1989
431. Mesa State College, Grand Junction, CO -- August 23, 1989
432. Pennsylvania State University at Erie, The Behrend College, Erie, PA -- April 2, 1990
433. Erskine College, Due West, SC -- April 9, 1990
434. Fairfield University, Fairfield, CT -- December 2, 1990
435. St. Norbert College, De Pere, WI -- April 3, 1991
436. Tarleton State University, Tarleton Station, TX -- October 15, 1993
437. California State University-Dominguez Hills, Carson, CA -- April 20, 1991
438. Hartwick College, Oneonta, NY -- November 9, 1991
439. New Mexico Institute of Mining & Technology, Socorro, NM -- November 20, 1991
440. Oglethorpe University, Atlanta, GA -- April 1, 1992
441. Bethany College, Bethany, WV -- May 7, 1992
442. Mt. Holyoke, South Hadley, MA -- May 9, 1992
443. Central Connecticut State, New Britain, CT -- May 14, 1992
444. Fort Lewis College, Durango, CO -- April 18, 1992
445. Drake University, Des Moines, IA -- May 1, 1992
446. Northeastern Illinois University, Chicago, IL -- December 20, 1992
447. Michigan-Flint, University of, Flint, MI -- March 19, 1993
448. Washington & Jefferson College, Washington, PA -- May 1, 1992
449. Southern Nazarene University, Bethany, OK -- February 19, 1994
450. Clark Atlanta University, Atlanta, GA -- May 6, 1994
451. Bethel University (Bethel College), St. Paul, MN -- May 17, 1994
452. SUNY at Brockport, Brockport, NY -- November 18, 1994
453. Rochester, University of, Rochester, NY -- November 30, 1994
454. Wheeling Jesuit University, Wheeling, WV -- April 27, 1995
455. McDaniel College (Western Maryland College), Westminster, MD -- May 4, 1995
456. East Central Oklahoma University, Ada, OK -- September 21, 1995
457. Longwood College, Farmville, VA -- January 27, 1996
458. Whittier College, Whittier, CA -- February 27, 1996
459. Catholic University of America, The, Washington, DC -- March 26, 1996
460. Millikin University, Decatur, IL -- March 28, 1996
461. Knox College, Galesburg, IL -- May 24, 1996
462. North Park University, Chicago, IL -- May 5, 1994
463. Connecticut College, New London, CT -- April 23, 1997

464. Centre College, Danville, KY -- January 18, 1996
465. Georgian Court College, Lakewood, NJ -- April 21, 1996
466. Spelman College, Atlanta, GA -- February 26, 1998
467. Hillsdale College, Hillsdale, MI -- April 22, 1998
468. Hendrix College, Conway, AR -- April 29, 1998
469. Cumberlands, University of the, (formerly Cumberland College), Williamsburg, KY -- May 8, 1998
470. Louisiana State University, Shreveport, LA -- June 18, 1988
471. San Diego, University of, San Diego, CA -- May 4, 1999
472. Wisconsin-LaCrosse, University of, La Crosse, WI -- May 1, 1999
473. New Mexico, University of, Albuquerque, NM -- 1999
474. Montana, University of, Bozeman, MT -- Oct. 22, 1999
475. Notre Dame, University of, Notre Dame, IN -- Feb. 24, 2000
476. Lawrence University, Appleton, WI -- June 1, 2000
477. Randolph-Macon Woman's College, Lynchburg, VA -- May 30, 2000
478. Ohio Northern University, Ada, OH -- June 7, 2000
479. Southwestern College, Winfield, KS -- 1999
480. Rowan University (Rowan College of New Jersey), Glassboro, NJ -- Oct. 23, 2000
481. Christian Brothers University, Memphis, TN -- Sept. 17, 2001
482. Allegheny College, Allegheny, PA -- April 26, 2002
483. Carnegie Mellon University, Pittsburgh, PA -- April 27, 2002
484. Texas at San Antonio, University of, San Antonio, TX -- May 1, 2001
485. Chicago State University, Chicago, IL -- May 6, 2002
486. Pacific University, Forest Grove, OR -- May 9, 2002
487. Embry-Riddle, Daytona Beach, FL -- Jan. 28, 2002
488. Skidmore College, Saratoga Springs, NY -- April 5, 2002
489. Kettering University, Flint, MI -- March 24, 2003
490. Kutztown University of Pennsylvania, Kutztown, PA -- April 28, 2003
491. Le Moyne College, Syracuse, NY -- Dec. 6, 2002
492. Coe College, Cedar Rapids, IA -- Apr. 4, 2004
493. St. Mary's University, San Antonio, TX -- April 30, 2004
494. Lafayette College, Easton, PA -- April 16, 2004
495. Dillard University, New Orleans, LA -- April 6, 2004
496. Ithaca College, Ithaca, NY -- April 27, 2004
497. Vermont, University of, Burlington, VT -- April 30, 2004
498. Wittenberg University, Springfield, OH -- May 12, 2004
499. Wartburg College, Waverly, IA -- May 18, 2004
500. Gustavus Adolphus College, St. Peter, MN -- May 23, 2004
501. Northwest Nazarene University (Northwest Nazarene College), Nampa, ID -- April 20, 2004
502. Colgate University, Hamilton, NY -- Nov. 16, 2004
503. Southeastern Louisiana University, Hammond, LA -- Feb. 25, 2005
504. Alabama A&M University, Huntsville, AL -- May 5, 2005
505. University of Central Florida, Orlando, FL -- March 25, 2005
506. Marietta College, Marietta, OH -- March 2, 2005
507. Brigham Young University-Idaho, Rexburg, ID -- Dec. 15, 2005
508. Embry Riddle Aeronautical University, Prescott, Arizona -- Jan. 13, 2006
509. Minnesota-Duluth, University of, Duluth, MN -- April 1, 2006
510. Indiana University-South Bend, South Bend, IN -- April 14, 2006
511. Radford University, Radford, VA -- April 25, 2006
512. Fisk University, Nashville, TN -- May 1, 2006
513. Ramapo College of New Jersey, Mahwah, NJ -- October 11, 2006
514. Mary Baldwin College, Staunton, VA -- May 12, 2007
515. St. Vincent College, Latrobe, PA -- April 28, 2007
516. Drury University, Springfield, MO -- May 4, 2007
517. Union University, Jackson, TN -- May 8, 2007
518. Jackson State University, Jackson, MS -- November 5, 2007
519. Carthage College, Kenosha, WI -- November 30, 2007
520. Washington & Lee University, Lexington, VA -- October 10, 2007
521. University of Wisconsin-Stevens Point, Stevens Point, WI -- Feb. 6, 2008
522. California State University, San Bernardino, CA -- March 6, 2008
523. Butler University, Indianapolis, IN -- April 23, 2008
524. Marshall University, Huntington, WV -- April 25, 2008
525. University of North Florida, Jacksonville, FL -- April 30, 2008
526. Elon University, Graham, NC -- May 13, 2008
527. Illinois State University, Normal, IL -- November 3, 2008
528. Seattle Pacific University, Seattle, WA -- November 24, 2008
529. Portland State University, Portland, OR -- December 18, 2008
530. Grand Valley State University, Allendale, MI -- Jan 1, 2009
531. Sonoma State University, Rohnert Park, CA -- Feb. 24, 2009
532. Washington University in St. Louis, MO -- April 24, 2009
533. South Carolina State University, Orangeburg, SC -- Feb. 24, 2009
534. St. Mary's College of Maryland, St. Mary's City, MD -- April 23, 2009
535. Stevens Institute of Technology, Hoboken, NJ -- March 27, 2009
536. University of Missouri, Columbia, MO -- 2010
537. California State University, San Marcos, CA -- 2010
538. Texas Lutheran University, Seguin, TX -- March 29, 2010
539. Houston Baptist University, Houston, TX -- June 2, 2010
540. Suffolk University, Boston, MA -- June 2, 2010
541. Augustana College, Rock Island, IL -- May 16, 2011
542. Tougaloo College, Tougaloo, MS -- May 1, 2011
543. University of Buffalo, SUNY, Buffalo, NY -- November 4, 2011
544. Kenyon College, Gambier, OH -- December 12, 2012
545. National University of Singapore, Singapore -- June 6, 2012
546. Gordon College, Wenham, MA -- April 6, 2012
547. Massachusetts College of Liberal Arts, North Adams, MA -- April 13, 2012
548. Simpson College, Indianola, IA -- April 24, 2013
549. Lebanon Valley College, Annville, PA -- April 20, 2013
550. Roberts Wesleyan College, Rochester, NY -- April 13, 2013
551. Christopher Newport University, Newport News, VA -- April 23, 2013
552. C.U.N.Y. - Lehman College, Bronx, NY -- July 18, 2013
553. Bryn Mawr College, Bryn Mawr, PA -- 5/17/2013
554. University of Texas at Rio Grande Valley-East, Brownsville, TX -- March 23, 2013
555. United States Air Force Academy, Colorado Spring, CO -- May 21, 2014
556. Saint Michael's College, Colchester, VT -- October 10, 2014
557. Kennesaw State University -- 4/1/2014
558. Purdue University - Fort Wayne, Fort Wayne, IN -- May 28, 2014
559. Doane College, Certe, NE -- July 22, 2014
560. Mercyhurst University, Erie, PA -- March 11, 2015
561. Norfolk State University, Norfolk, VA -- May 5, 2015
562. Georgia College and State University, Milledgeville, GA -- July 16, 2015
563. Messiah College, Mechanicsburg, PA -- December 1, 2015
564. Missouri Southern State University, Joplin, MO -- October 1, 2015
565. Xavier University of Louisiana, New Orleans, LA -- November 10, 2015
566. Bridgewater College, Bridgewater, VA -- November 20, 2015
567. Florida Atlantic University, Boca Raton, FL -- December 17, 2015
568. Salisbury University Salisbury, MD -- January 12, 2016
569. Rockhurst University, Kansas City, MO -- June 17, 2016
570. University of Colorado, Denver, Denver, CO -- February 24, 2017
571. West Virginia Wesleyan College Buckhannon, WV -- February 24, 2017
572. Berry College Mount Berry, GA -- April 29, 2017
573. Metropolitan State University of Denver, Denver, CO -- March 24, 2017
574. California Lutheran University Thousand Oaks, CA -- April 24, 2017
575. University of the Sciences Philadelphia, PA -- May 2, 2017
576. University of Washington, Bothell Bothell, WA -- March 24, 2017
577. University of Nevada-Las Vegas Las Vegas, NV -- 8/21/2017
578. Wofford College Spartanburg, SC -- April 24, 2018
579. High Point University High Point, NC -- April 9, 2018
580. Saint Anselm College Manchester, NH -- April 16, 2018
581. University of Wisconsin-Parkside Parkside, WI -- April 11, 2019
582. New College of Florida, Sarasota, FL -- April 11, 2019
583. Brown University Providence, RI -- February 21, 2020
584. Yale University New Haven Connecticut -- October 6, 2020
585. Kalamazoo College Kalamazoo, MI -- May, 19, 2022
586. University of Alabama Birmingham, AL -- April 8, 2022
587. Saint Mary's College Notre Dame, ID -- May 13, 2022
588. Purdue University-Northwest Hammond, IN -- April 29, 2022
589. Florida Polytechnic University Lakewood, FL -- May 3, 2022

# Get involved in SPS



Join SPS online now!  
[membership.spsnational.org](https://membership.spsnational.org)

## Why Join the National Organization?

[spsnational.org/about/membership](https://spsnational.org/about/membership)

- *Physics Today* – An award-winning, monthly publication
- PhysCon - The largest undergraduate conference for physics and astronomy majors
- Eligibility for scholarships: SPS Leadership, SPS Future Teacher, and several others
- *The SPS Observer* – A quarterly magazine written for undergraduate physics and astronomy majors
- Research and travel grants for regional and national meetings
- Free membership in two AIP Member Societies for up to three years (undergraduates only)
- Free joint membership in the National Society of Black Physicists (NSBP) or the National Society of Hispanic Physicists (NSHP)
- Eligibility for outreach and chapter monetary awards
- *SPS News* eNewsletter (bi-weekly) – Featuring upcoming meetings, awards, scholarships and jobs
- Careers Toolbox for Physics Students – Everything you need to be successful in your internship or job hunt
- Professional development opportunities
- Undergraduate-specific regional conferences and meetings
- Opportunity to run for the SPS council
- Serve on SPS committees and gain leadership skills
- Participation in advocacy
- Opportunity to apply for free Science Outreach Catalyst Kits (SOCKs)
- Support the physics community through outreach and community service events

## Submit Annual Chapter Reports

[spsnational.org/resources/chapters](https://spsnational.org/resources/chapters)

Collecting and sharing information about how SPS functions at the chapter level is imperative for the society as a whole. All chapters are strongly encouraged to record events, activities, successes, and challenges to produce an annual record of the chapter.

## Update SPS Membership Information

[membership.spsnational.org](https://membership.spsnational.org)

Encourage student and faculty members to keep their membership up-to-date to ensure timely delivery of benefits!

## Update Chapter Information

[membership.spsnational.org](https://membership.spsnational.org)

Make sure that your leadership and contact information is up to date.

## Find SPS Chapter & Zone Leaders

[spsnational.org/about/governance/zones](https://spsnational.org/about/governance/zones)

This zone map is linked to zone leadership and chapter directories.

## Find SPS Constitution & Bylaws

[spsnational.org/about/governance/constitution](https://spsnational.org/about/governance/constitution)

The constitution and bylaws of the SPS Organization can be used as models for chapter governance documents.

## Start a Sigma Pi Sigma Chapter

[sigmapisigma.org/about/chapter-resources](https://sigmapisigma.org/about/chapter-resources)

Sigma Pi Sigma chapters are restricted to colleges and universities of recognized standing that offer a strong physics major.

## Induct Sigma Pi Sigma Members

[sigmapisigma.org/sigmapisigma/induction-center](https://sigmapisigma.org/sigmapisigma/induction-center)

Inductions are faster and easier with our user-friendly induction platform. Also, find formal induction resources and procedures.

## Find Everything in this Book & More Online at:

[spsnational.org/about/governance/sp-s-information-handbook](https://spsnational.org/about/governance/sp-s-information-handbook)



The Society of Physics Students & Sigma Pi Sigma

American Institute of Physics

1 Physics Ellipse • College Park, MD 20740 • Tel: +1 301.209.3007

[sps@aip.org](mailto:sps@aip.org) | [spsnational.org](https://spsnational.org) | [sigmapisigma.org](https://sigmapisigma.org)

